

AS-F232
AS-F422
AS-F485
AS-FCOPM

EN Instruction Sheet
 TR Bilgi Dökümanı
 TW 安裝說明
 CN 安装说明



5014035603



- EN ✎ This is an OPEN TYPE module and therefore should be installed in an enclosure free of airborne dust, humidity, electric shock and vibration. The enclosure should prevent non-maintenance staff from operating the device (e.g. key or specific tools are required for operating the enclosure) in case danger and damage on the device may occur.
- FR ✎ Ceci est un module ouvert et il doit donc être installé dans un coffret à l'abri des poussières, des vibrations et ne pas être exposé aux chocs électriques. Le boîtier ou l'armoire doit éviter toute action d'un personnel autre que celui affecté à la maintenance de l'appareil (par exemple, clefs, outils spécifiques pour l'ouverture du coffret), ceci afin d'éviter tout accident corporel ou endommagement du produit).
- TR ✎ Bu ürün AÇIK TİP bir modül olup toz, rutubet, elektrik şoku ve titreşimden uzak kapalı yerlerde muhafaza edilmelidir. Yanlış kullanım sonucu ürünün zarar görmesini önlemek için yetkili olmayan kişiler tarafından ürüne müdahale edilmesini önleyecek koruyucu önlemler alınmalıdır. (Ürünün bulunduğu panoya kilit konulması gibi).
- TW ✎ 本機為開放型 (OPEN TYPE) 機種，因此使用者使用本機時，必須將之安裝於具防塵、防潮及免於電擊/衝擊意外之外殼配線箱內。另必須具備保護措施 (如：特殊之工具或鑰匙才可打開) 防止非維護人員操作或意外衝擊本體，造成危險及損壞。
- CN ✎ 本机为开放型 (OPEN TYPE) 机种，因此使用者使用本机时，必须将其安装于具防尘、防潮及免于电击/冲击意外的外壳配线箱内。另必须具备保护措施 (如：特殊的工具或钥匙才可打开) 防止非维护人员操作或意外冲击本体，造成危险及损坏。

EN Please refer to the AS Series Hardware and Operation Manual for more information.

TR Daha fazla bilgi için lütfen AS Serisi Donanım ve Kullanım Klavuzuna bakınız.

TW 詳細資料請參考 AS 系列硬體及操作手冊

CN 详细资料请参考 AS 系列硬件及操作手册

EN Assembly TR Montaj TW 安裝 CN 组装

EN Installation: Put the function card directly into the function card slot until hearing a click.

Removal: Press  , and pull out the function card.

TR Kurulum : Genişleme kartını doğrudan genişleme kart yuvasına klik sesi duyuncaya kadar itiniz.

Çıkarma :  basınız ve genişleme kartını çekiniz.

TW 安裝：將擴充卡直接放入功能卡槽直至喀一聲。

拆卸：按壓  處，並將功能卡抽出。

CN 安装：将扩充卡直接放入功能卡槽直至喀一声。

拆卸：按压  处，并将功能卡抽出。

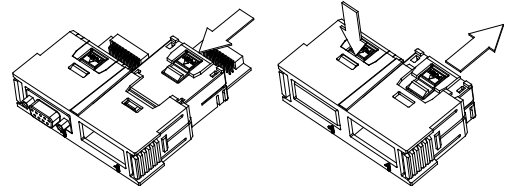

EN Wiring TR Bağlantı TW 配線 CN 配线

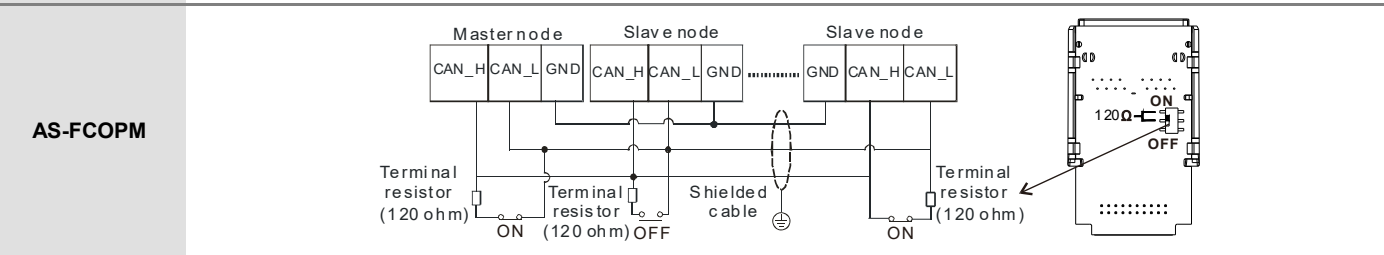
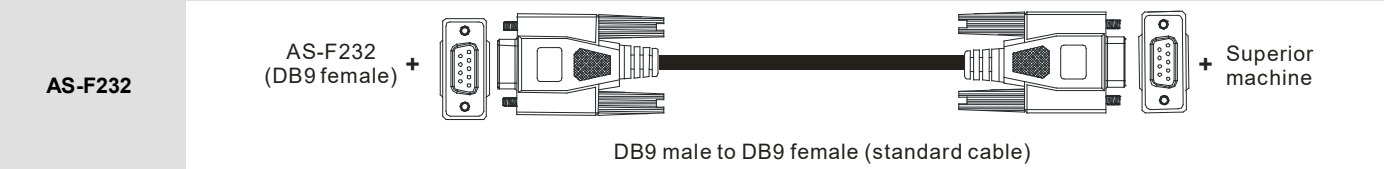

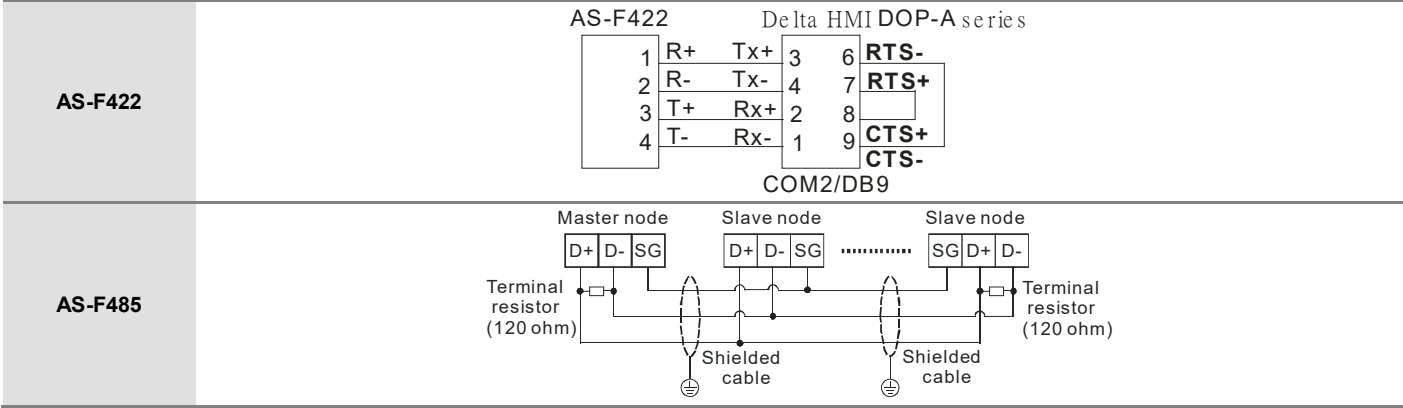

EN Dimensions(mm) & Product Profile

TR Ölçüler(mm) & Ürün Görünüşü

TW 尺寸 (mm) 及產品外觀

CN 尺寸 (mm) 及產品外觀

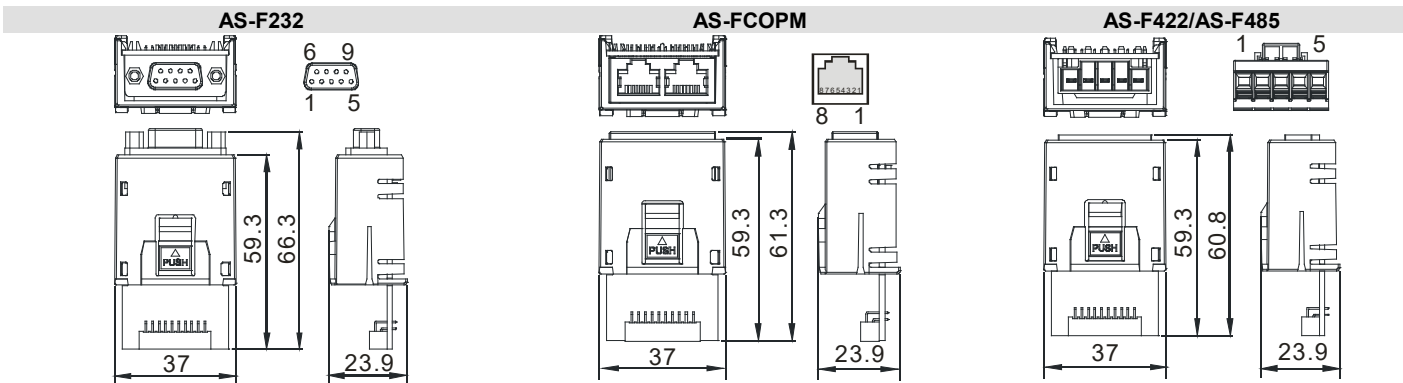

EN Pin definition	TR Pin açıklama	TW 接腳定義	CN 引腳定義
Pin no.	AS-F232	AS-FCOPM	AS-F422
1	-	CAN_H	R+
2	TX	CAN_L	R-
3	RX	GND	T+
4	-	-	T-
5	GND	-	SG
6-9	-	-	
			AS-F485
			D+
			D-
			SG

部件名称 Part Name	有毒物质-Hazardous Substances					
	铅 (Pb)	汞 (Hg)	镉 (Cd)	六价铬 (Cr VI)	多溴联苯 (PBB)	多溴二苯醚 (PBDE)
金属部件 Metal Part	X	O	O	O	O	O
塑料部件 Plastic Part	O	O	O	O	O	O
电子件 Electronic	X	O	O	O	O	O
触点 Contacts	O	O	X	O	O	O
线缆和线缆附件 Cable & Cabling accessories	X	O	O	O	O	O
电池 Battery	O	O	O	O	O	O