

AS32AM10N-A

EN Instruction Sheet
TR Bilgi Dökümanı
TW 安裝說明
CN 安装说明



5014034502



- EN ✎ This is an OPEN TYPE module and therefore should be installed in an enclosure free of airborne dust, humidity, electric shock and vibration. The enclosure should prevent non-maintenance staff from operating the device (e.g. key or specific tools are required for operating the enclosure) in case danger and damage on the device may occur.
- FR ✎ Ceci est un module ouvert et il doit donc être installé dans un coffret à l'abri des poussières, des vibrations et ne pas être exposé aux chocs électriques. Le boîtier ou l'armoire doit éviter toute action d'un personnel autre que celui affecté à la maintenance de l'appareil (par exemple, clefs, outils spécifiques pour l'ouverture du coffret), ceci afin d'éviter tout accident corporel ou endommagement du produit).
- TR ✎ Bu ürün AÇIK TİP bir modül olup toz, rutubet, elektrik şoku ve titreşimden uzak kapalı yerlerde muhafaza edilmelidir. Yanlış kullanım sonucu ürünün zarar görmesini önlemek için yetkili olmayan kişiler tarafından ürüne müdahale edilmesini önleyecek koruyucu önlemler alınmalıdır. (Ürünün bulunduğu panoya kilit konulması gibi).
- TW ✎ 本機為開放型 (OPEN TYPE) 機種，因此使用者使用本機時，必須將之安裝於具防塵、防潮及免於電擊衝擊意外之外殼配線箱內。另必須具備保護措施 (如：特殊之工具或鑰匙才可打開) 防止非維護人員操作或意外衝擊本體，造成危險及損壞。
- CN ✎ 本機為開放型 (OPEN TYPE) 機種，因此使用者使用本機時，必須將其安裝於具防塵、防潮及免于電擊/冲击意外的外殼配線箱內。另必須具備保護措施 (如：特殊的工具或鑰匙才可打開) 防止非維護人員操作或意外冲击本體，造成危險及損壞。

EN Please refer to the AS Series Hardware and Operation Manual for more information

TR Daha fazla bilgi için lütfen AS Serisi Donanım ve Kullanım Klavuzuna bakınız.

TW 詳細資料請參考 AS 系列硬體及操作手冊

CN 详细资料请参考 AS 系列硬件及操作手册

EN Assembly

TR Montaj

TW 安裝

CN 组装

EN Clip up the two DIN rail clip on the module. Parallel the module groove on the back to the DIN rail, then push and slide along until hearing a click.

TR Modül üzerindeki iki DIN ray klipsini dışa doğru çekin. Altındaki modül oyuğunu DIN ray ile paralel konuma getiriniz ve sonra klik sesini duyana kadar klipsleri içe doğru bastırın.

TW 將模組上下方的兩個 DIN 軌固定扣往中間壓後，將模組後方勾槽平行對準 DIN 軌並往 DIN 軌壓直到喀一聲，即完成。

CN 將模块上下方的两个 DIN 轨固定扣往中间压后，將模块后方勾槽平行对準 DIN 轨并往 DIN 轨压直到喀一聲，即完成。

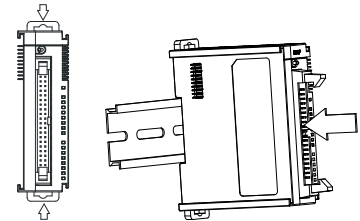

EN Input

TR Girişler

TW 輸入

CN 輸入

EN Input type: ① SINK ② SOURCE

TR Giriş Tipi: ① SINK ② SOURCE

TW 輸入接線：① 漏型輸入方式 ② 源型輸入方式

CN 輸入接線：① 漏型輸入方式 ② 源型輸入方式

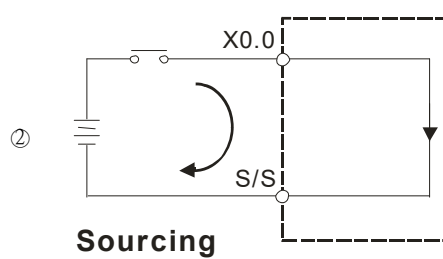
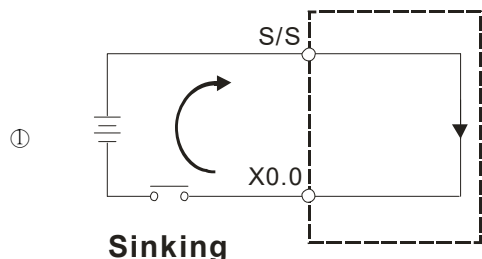

	-	-
	S/S	S/S
	1.15	1.14
	1.13	1.12
	1.11	1.10
	1.9	1.8
	1.7	1.6
	1.5	1.4
	1.3	1.2
	1.1	1.0
	-	-
	S/S	S/S
	0.15	0.14
	0.13	0.12
	0.11	0.10
	0.9	0.8
	0.7	0.6
	0.5	0.4
	0.3	0.2
	0.1	0.0

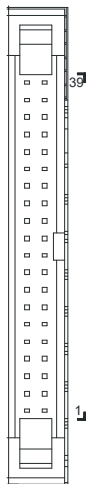

EN Dimensions(mm) & Product Profile
 TR Ölçüler(mm) & Ürün Görünüşü
 TW 尺寸 (mm) 及產品外觀
 CN 尺寸 (mm) 及產品外觀

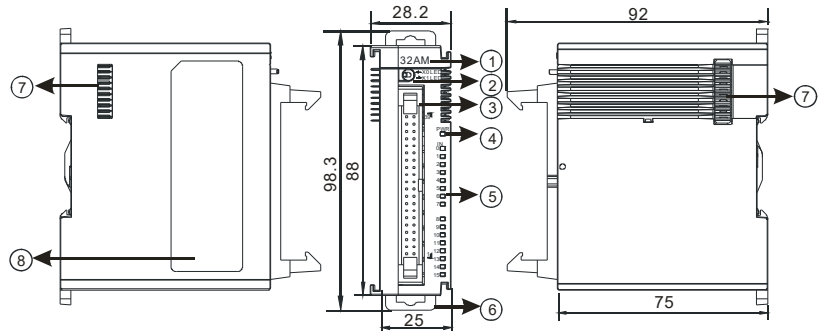

EN	TR	TW	CN
1 Model name	Model adı	機種名稱	机种名称
2 X0/X1 LED switch	X0/X1 LED anahtarı	X0/X1 LED 開關	X0/X1 LED 开关
3 MIL connector	MIL konnektör	牛角座連接器	牛角座连接器
4 Power indicator	Besleme göstergesi	電源指示燈	电源指示灯
5 Input LED indicator	Girişler LED göstergesi	輸入指示燈	输入指示灯
6 DIN rail clip	DIN ray klipsi	DIN 軌固定扣	DIN 轨固定扣
7 Extension module communication port	Genişleme modülü iletişim portu	擴充模組通訊埠	扩充模块通讯端口
8 Label	Etiket	標籤	标签

EN Wiring	TR Bağlantı	TW 配線	CN 配线
-----------	-------------	-------	-------

EN I/O extension cable UC-ET010-24B / UC-ET020-24B / UC-ET030-24B
 External terminal module UB-10-ID32A(mm)

TR I/O ilave kablosu UC-ET010-24B / UC-ET020-24B / UC-ET030-24B
 Harici terminal modülü UB-10-ID32A(mm)

TW I/O 連接線 UC-ET010-24B / UC-ET020-24B / UC-ET030-24B
 I/O 配線模組 UB-10-ID32A(mm)

CN I/O 连接线 UC-ET010-24B / UC-ET020-24B / UC-ET030-24B
 I/O 配线模块 UB-10-ID32A(mm)

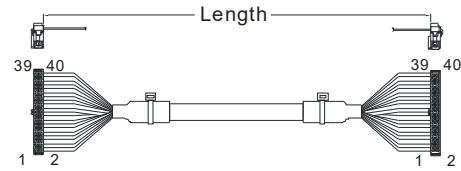

Length:
 UC-ET010-24B(1M)
 UC-ET020-24B(2M)
 UC-ET030-24B(3M)

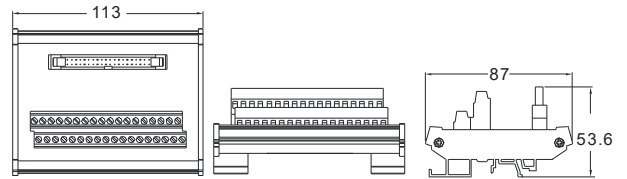

部件名称 Part Name	有毒物质-Hazardous Substances					
	铅 (Pb)	汞 (Hg)	镉 (Cd)	六价铬 (Cr VI)	多溴联苯 (PBB)	多溴二苯醚 (PBDE)
金属部件 Metal Part	x	o	o	o	o	o
塑料部件 Plastic Part	o	o	o	o	o	o
电子件 Electronic	x	o	o	o	o	o
触点 Contacts	o	o	x	o	o	o
线缆和线缆附件 Cable & Cabling accessories	x	o	o	o	o	o
电池 Battery	o	o	o	o	o	o