

# MicroSmart FC6A All-in-One PLC

## CPU Module Specifications



### PRODUCT DESCRIPTION

MicroSmart FC6A All-in-One, a powerful PLC with up to 520 digital I/O and 126 analog I/O. The MicroSmart FC6A provides the power of a PAC (programmable automation controller) in a low-cost controller with a small form factor, making it an ideal fit for demanding applications. Available in 12VDC, 24VDC, and 100-240VAC.

### KEY FEATURES

- iOS and Android WindEDIT App
- Bluetooth communication
- Embedded Ethernet port
- Embedded SD memory port
- Modbus TCP and RTU
- Embedded RS232C/RS485 user selectable
- Maximum 520 digital I/O
- Maximum 126 analog I/O
- Data Logging
- Web Server Functions
- Large programming and data memory
- SAE J1939 CPU
- -25 to 65 degrees C operating temperature

### STANDARD BASE MODULE

Part Number	Total I/O	Power Voltage	Input Voltage	Output Type	Maximum Digital I/O	Maximum Analog I/O	
FC6A-C16R1AE	16 (9 inputs, 7 outputs)	100-240V AC	24V DC Sink/Source	Relay	400	100	
FC6A-C16R1CE		24V DC		Relay			
FC6A-C16P1CE				Transistor Source			
FC6A-C16K1CE				Transistor Sink			
FC6A-C16R1DE	16 (9 inputs, 7 outputs)	12V DC	12V DC Sink/Source	Relay	152	36	
FC6A-C16P1DE				Transistor Source			
FC6A-C16K1DE				Transistor Sink			
FC6A-C24R1AE				100-240V AC			24V DC Sink/Source
FC6A-C24R1CE	24V DC	Relay					
FC6A-C24P1CE		Transistor Source					
FC6A-C24K1CE		Transistor Sink					
FC6A-C40R1AE	40 (24 inputs, 16 outputs)	100-240V AC	24V DC Sink/Source	Relay	520	126	
FC6A-C40R1CE		24V DC		Relay			
FC6A-C40P1CE				Transistor Source			
FC6A-C40K1CE				Transistor Sink			
FC6A-C40R1DE		12V DC		12V DC Sink/Source	Relay	40	6
FC6A-C40P1DE					Transistor Source		
FC6A-C40K1DE					Transistor Sink		

### CAN J1939 BASE MODULE

Part Number	Total I/O	Power Voltage	Input Voltage	Output Type	Maximum Digital I/O	Maximum Analog I/O			
FC6A-C40R1AEJ	40 (24 inputs, 16 outputs)	100-240V AC	24V DC Sink/Source	Relay	250	126			
FC6A-C40R1CEJ		24V DC		Relay					
FC6A-C40P1CEJ				Transistor Source					
FC6A-C40K1CEJ				Transistor Sink					
FC6A-C40R1DEJ		12V DC		12V DC Sink/Source			Relay		
FC6A-C40P1DEJ							Transistor Source		
FC6A-C40K1DEJ							Transistor Sink		



## SPECIFICATIONS

Part Number	FC6A-C16R1AE FC6A-C16R1CE FC6A-C16P1CE FC6A-C16K1CE FC6A-C16R1DE FC6A-C16P1DE FC6A-C16K1DE	FC6A-C24R1AE FC6A-C24R1CE FC6A-C24P1CE FC6A-C24K1CE	FC6A-C40R1AE FC6A-C40R1CE FC6A-C40P1CE FC6A-C40K1CE FC6A-C40R1DE FC6A-C40P1DE FC6A-C40K1DE	FC6A-C40R1AEJ FC6A-C40R1CEJ FC6A-C40P1CEJ FC6A-C40K1CEJ FC6A-C40R1DEJ FC6A-C40P1DEJ FC6A-C40K1DEJ
Rated Power Voltage	AC: 100 to 240V AC, DC: 24V DC, 12V DC			
Allowable Voltage Range	AC: 85 to 264V AC 24V DC: 20.4 to 28.8V DC (including ripple), 12V DC: 10.2 to 18.0V			
Rated Frequency	AC: 50/60Hz (47 to 63 Hz)			
Maximum Power Consumption (CPU module)	AC	FC6A-C16R1AE: 100-240V AC, 33VA FC6A-C24R1AE: 100-240V AC, 35VA	FC6A-C40R1AE: 100-240V AC, 41VA FC6A-C40R1AEJ: 100-240V AC, 37VA	
	DC	FC6A-C16R1CE: 24V DC 140mA, 3.36W FC6A-C24R1CE: 24V DC 155mA, 3.72W FC6A-C40R1CE: 24V DC 195mA, 4.68W FC6A-C16P1CE: 24V DC 190mA, 4.6W FC6A-C24P1CE: 24V DC 200mA, 4.8W FC6A-C40P1CE: 24V DC 205mA, 5.0W FC6A-C16K1CE: 24V DC 190mA, 4.6W FC6A-C24K1CE: 24V DC 200mA, 4.8W	FC6A-C40K1CE: 24V DC 205mA, 5.0W FC6A-C16R1DE: 12V DC 270mA, 3.24W FC6A-C40R1DE: 12V DC 345mA, 4.14W FC6A-C16P1DE: 12V DC 260mA, 3.12W FC6A-C40P1DE: 12V DC 260mA, 3.12W FC6A-C16K1DE: 12V DC 250mA, 3.0W FC6A-C40K1DE: 12V DC 260mA, 3.12W FC6A-C40R1CEJ: 24V DC 205mA, 5.0W FC6A-C40P1CEJ: 24V DC 175mA, 4.2W FC6A-C40K1CEJ: 24V DC 175mA, 4.2W FC6A-C40R1DEJ: 12V DC 340mA, 4.08W FC6A-C40P1DEJ: 12V DC 320mA, 3.9W FC6A-C40K1DEJ: 12V DC 320mA, 3.9W	
Inrush Current	AC: 40A maximum 24V DC: 35A maximum 12V DC: 35A maximum			
Allowable Momentary Power Interruption	10 ms (at rated voltage)			
Dielectric Strength	AC	Between power and PE terminals: 1,500V AC, 1 minute Between relay output and PE terminals: 2,300V AC, 1 minute Between power and relay output terminals: 2,300V AC, 1 minute	Between input and PE terminals: 1,500V AC, 1 minute Between power and input terminals: 1,500V AC, 1 minute Between input and relay output terminals: 2,300V AC, 1 minute	
	DC	Between power and FE terminals: 500V AC, 1 minute Between transistor output and FE terminals: 500V AC, 1 minute Between power and input terminals: 500V AC, 1 minute Between power and relay output terminals: 2,300V AC, 1 minute Between input and relay output terminals: 2,300V AC, 1 minute	Between input and FE terminals: 500V AC, 1 minute Between relay output and FE terminals: 2,300V AC, 1 minute Between power and transistor output terminals: 500V AC, 1 minute Between input and transistor output terminals: 500V AC, 1 minute	
Insulation Resistance	AC	Between power and PE terminals: 100 MΩ or higher (500V DC megger) Between relay output and PE terminals: 100 MΩ or higher (500V DC megger) Between power and relay output terminals: 100 MΩ or higher (500V DC megger)	Between input and PE terminals: 100 MΩ or higher (500V DC megger) Between power and input terminals: 100 MΩ or higher (500V DC megger) Between input and relay output terminals: 100 MΩ or higher (500V DC megger)	
	DC	Between power and FE terminals: 100 MΩ or higher (500V DC megger) Between transistor output and FE terminals: 100 MΩ or higher (500V DC megger) Between power and input terminals: 100 MΩ or higher (500V DC megger) Between power and relay output terminals: 100 MΩ or higher (500V DC megger) Between input and relay output terminals: 100 MΩ or higher (500V DC megger)	Between input and FE terminals: 100 MΩ or higher (500V DC megger) Between relay output and PE terminals: 100 MΩ or higher (500V DC megger) Between power and transistor output terminals: 100 MΩ or higher (500V DC megger) Between input and transistor output terminals: 100 MΩ or higher (500V DC megger)	
Power Supply Wire	UL1007 AWG24-16, UL2464 AWG24-16, UL1015 AWG20-16			
Grounding Wire	UL1007, AWG16			
Ground	D-type ground (Class 3 ground)			
Mounting	DIN rail or panel mounting			
Weight	FC6A-C16R1AE: 370g FC6A-C16R1CE: 350g FC6A-C16P1CE: 340g FC6A-C16K1CE: 340g FC6A-C16R1DE: 350g FC6A-C16P1DE: 340g FC6A-C16K1DE: 340g	FC6A-C24R1AE: 420g FC6A-C24R1CE: 400g FC6A-C24P1CE: 380g FC6A-C24K1CE: 380g	FC6A-C40R1AE: 560g FC6A-C40R1CE: 530g FC6A-C40P1CE: 480g FC6A-C40K1CE: 480g FC6A-C40R1DE: 560g FC6A-C40P1DE: 530g FC6A-C40K1DE: 530g	FC6A-C40R1AEJ: 560g FC6A-C40R1CEJ: 530g FC6A-C40P1CEJ: 480g FC6A-C40K1CEJ: 480g FC6A-C40R1DEJ: 560g FC6A-C40P1DEJ: 530g FC6A-C40K1DEJ: 530g

Note: For operating conditions, see page 8.

## FUNCTION SPECIFICATIONS

Part Number	FC6A-C16R1AE FC6A-C16R1CE FC6A-C16P1CE (*5) FC6A-C16K1CE (*5) FC6A-C16R1DE FC6A-C16P1DE (*5) FC6A-C16K1DE (*5)	FC6A-C24R1AE FC6A-C24R1CE FC6A-C24P1CE (*5) FC6A-C24K1CE (*5)	FC6A-C40R1AE FC6A-C40R1CE FC6A-C40P1CE (*5) FC6A-C40K1CE (*5) FC6A-C40R1DE FC6A-C40P1DE (*5) FC6A-C40K1DE (*5)	FC6A-C40R1AEJ FC6A-C40R1CEJ FC6A-C40P1CEJ (*5) FC6A-C40K1CEJ (*5) FC6A-C40R1DEJ FC6A-C40P1DEJ (*5) FC6A-C40K1DEJ (*5)
Control System	Stored program system			
Instruction Words	Basic	42		
	Advanced	129		
Program Capacity (*1)	384KB (48,000 steps)/72KB (9,000 steps) (*2)			640KB (80,000 steps) 72KB (9,000 steps) (*2)
User Program Download	1,000 times			
Processing Time	Basic Instruction	42μs/1,000 steps		
	END Processing (*3)	1ms maximum		
I/O Points	Input	9 points	14 points	24 points
	Output	7 points	10 points	16 points
Expandable Modules	4 modules		7 modules	
Expandable I/O Points with Expansion Modules	128 points		224 points	
Expandable Modules with Unibody Type	8 modules			
Expansion Interface Modules	256 points			
Expandable I/O Points with Expansion Interface Modules	12,400 points			
Internal Relay	256 points			
Special Internal Relay	256 points			
Shift Register	54,000 points			
Data Register	500 points			
Special Data Register	512 points			
Counter	1,024 points			
Timer (1ms, 10ms, 100ms, 1s)	Clock accuracy: ±30 sec/month (typical) at 25°C			
RAM Backup	Backup Data	RAM (internal relay, shift register, counter, data register), clock data (*9)		
	Battery (enclosed with products)	Lithium primary battery (part number of enclosed batteries cannot be selected) Panasonic: BR2032 / CR2032A / CR2032B Murata: CR2032X / CR2032W		
	Battery Life	1-year warranty (replacement approx. 4 years (+25°C)) (*10)		
	Replaceability	Replace within one minute after power off (recommended) (*6)		
Self-diagnostic Function	Keep data, user program (ROM) CRC check, timer/counter preset value change check, user program syntax check, user program execution check, watchdog timer check, user program download check, power failure, clock error, data link connection check, expansion bus initialization check, system check, SD memory card transfer check, SD memory card access check			
Input Filter	0 ms (without filter), 3 to 15ms (selectable in increments of 1ms)			
Catch Input/Interrupt Input	Six inputs I0, I1, I6, I7 (Minimum turn on pulse width: 5μs max., Minimum turn off pulse width: 5μs max.) I3, I4 (Minimum turn on pulse width: 35μs max., Minimum turn off pulse width: 35μs max.)			
High-speed Counter	Maximum Counting Frequency and High-speed Counter Points	Total 6 points Single/two-phase selectable: 100 kHz (single-phase: 4 points, two-phase: 2 points) Single-phase: 5 kHz (2 points)		
	Counting Range	0 to 4,294,967,295 (32 bits)		
	Operation Mode	Rotary encoder mode, adding counter mode, frequency measurement mode		
Analog Potentiometer	Quantity	1 point		
	Data Range	0 to 1,000		
Analog Voltage Input	Quantity	1 point		
	Input Voltage Range	0 to 10V		
	Input Impedance	Approx. 100KΩ		
	Digital Resolution	Approx. 1,000 steps (10 bits)		
Pulse Output (transistor output model only)	Quantity	4 points		
	Maximum Output Pulse Frequency	Q0, Q1: 100 kHz	Q2, Q3: 5 kHz	Q0, Q2, Q4, Q6: 100 kHz
	Reversible Control	Single-pulse output mode: 2 axis (Q0-Q3)		
		Dual-pulse output mode: 1 axis (Q0-Q1)		
	PWM Output	Duty cycle 0.1 to 100.0% (increments of 0.1%) Output pulse frequency 15 to 5,000 (increments of 1 Hz): 4 points (Q0-Q3) *Q0, Q1: Adjust 5μs minimum as ON time and 15μs minimum as OFF time. *Q2, Q3: Adjust 100μs minimum as ON/OFF time.		
Output pulse frequency: 15 to 5,000 (increments of 1 Hz): 4 points (Q0, Q2, Q4, Q6) * Adjust 5μs minimum as ON time and 15μs minimum as OFF time.				
External Power Supply for Sensor (*8) (AC only)	Output Voltage/Current	24V (+10%, -15%) / 250mA		
	Overload Detection Isolation from the internal circuit	Not possible Transformer-isolated		
USB Port	USB mini-B (maintenance communication)			
Serial Port 1, CAN Port	RS232C or RS485 (*4)			CAN J1939
Ethernet Port 1	Ethernet (maintenance communication, user communication, Modbus TCP server/client)			
SD Card Slot	Embedded (*7)			
Cartridge (option) (*8)	One cartridge can be added on CPU module		Two cartridges can be added on CPU module	
	One cartridge can be added on HMI module (FC6A-PH1)		One cartridge can be added on HMI module (FC6A-PH1)	
HMI Module (option) (*8)	Yes	Yes	Yes	Yes

\*1) 1 step equals 8 bytes. \*2) When 72KB is selected, download function can be used during RUN.

\*3) Not including expansion I/O service time, counter timer processing time, data link processing time, and interrupt processing time.

\*4) Maintenance communication, user communication, data link, Modbus RTU master/slave communication. \*5) Transistor output model

\*6) Batteries can be replaced when power is on or replaced while power is supplied from USB bus power \*7) SD memory cards (max 2 GB), SDHC memory cards (max 32 GB)

\*8) External power supplies for sensor, cartridges and HMI Modules cannot be used under the expanded ambient operating temperature (-25 to -10°C, +55 to +65°C).

\*9) RAM backup data can be saved in a non-volatile memory using the SD card receipt function.

\*10) 1-year warranty conditions include operating environments (temperature/humidity) during power off and power on.

Note: The maximum number of relay outputs that can be turned on simultaneously is limited. The upper limit varies on the expanded ambient operating temperature (-25 to -10°C, +55 to +65°C).

## USB PORT SPECIFICATIONS

Part Number	FC6A-C16R1AE FC6A-C16R1CE FC6A-C16P1CE FC6A-C16K1CE FC6A-C16R1DE FC6A-C16P1DE FC6A-C16K1DE	FC6A-C24R1AE FC6A-C24R1CE FC6A-C24P1CE FC6A-C24K1CE	FC6A-C40R1AE FC6A-C40R1CE FC6A-C40P1CE FC6A-C40K1CE FC6A-C40R1DE FC6A-C40P1DE FC6A-C40K1DE	FC6A-C40R1AEJ FC6A-C40R1CEJ FC6A-C40P1CEJ FC6A-C40K1CEJ FC6A-C40R1DEJ FC6A-C40P1DEJ FC6A-C40K1DEJ
USB Type	USB mini-B			
USB Standard	USB 2.0 full speed			
Isolation	Not isolated from the internal circuit			
Communication Function	Maintenance communication to PC			

## SERIAL PORT 1, CAN PORT

Part Number	FC6A-C16R1AE FC6A-C16R1CE FC6A-C16P1CE FC6A-C16K1CE FC6A-C16R1DE FC6A-C16P1DE FC6A-C16K1DE	FC6A-C24R1AE FC6A-C24R1CE FC6A-C24P1CE FC6A-C24K1CE	FC6A-C40R1AE FC6A-C40R1CE FC6A-C40P1CE FC6A-C40K1CE FC6A-C40R1DE FC6A-C40P1DE FC6A-C40K1DE	FC6A-C40R1AEJ FC6A-C40R1CEJ FC6A-C40P1CEJ FC6A-C40K1CEJ FC6A-C40R1DEJ FC6A-C40P1DEJ FC6A-C40K1DEJ
Port Type	Serial port 1			CAN port
Communication Type	RS232C or RS485 selectable			CAN
Connector	RJ45			Terminal Block (5-pin)
Cable	CAT. 5 or higher STP			SAE J1939-11/SAE J1939-15
Maximum Baud Rate	115,200 bps			SAE J1939-11: 250 kbps: 40m, stubs, 1m maximum
Maximum Cable Length	RS232C: 5m, RS485: 200m			SAE J1939-15: 250 kbps: 40m, stubs, 3m maximum
Isolation	Not isolated from the internal circuit			Isolated from the internal circuit
Communication Function	Maintenance communication, user communication, Modbus RTU (master/slave)			J1939

## ETHERNET PORT 1

Part Number	FC6A-C16R1AE FC6A-C16R1CE FC6A-C16P1CE FC6A-C16K1CE FC6A-C16R1DE FC6A-C16P1DE FC6A-C16K1DE	FC6A-C24R1AE FC6A-C24R1CE FC6A-C24P1CE FC6A-C24K1CE	FC6A-C40R1AE FC6A-C40R1CE FC6A-C40P1CE FC6A-C40K1CE FC6A-C40R1DE FC6A-C40P1DE FC6A-C40K1DE	FC6A-C40R1AEJ FC6A-C40R1CEJ FC6A-C40P1CEJ FC6A-C40K1CEJ FC6A-C40R1DEJ FC6A-C40P1DEJ FC6A-C40K1DEJ
Communication Type	IEEE802.3 compliant			
Data Transfer	10BASE-T, 100BASE-TX			
Connector	RJ45			
Cable	CAT. 5 or higher STP			
Maximum Cable Length	100m			
Isolation	Pulse transformer isolation			
Communication Function	Maintenance communication server, User communication (server/client), Modbus TCP (server/client), PING, SNTP			

## CAN J1939

Part Number	FC6A-C40P1CEJ FC6A-C40P1DEJ	FC6A-C40K1CEJ FC6A-C40K1DEJ	FC6A-C40R1AEJ FC6A-C40R1DEJ	FC6A-C40R1CEJ
Supported SAE J1939	SAE J1939-11: Physical Layer, 250K bits/s, Twisted Shielded Pair SAE J1939-15: Reduced Physical Layer, 250K bits/s, Unshielded Twisted Pair SAE J1939-21: Data Link Layer		SAE J1939-71: Vehicle Application Layer SAE J1939-73: Application Layer - Diagnostics SAE J1939-75: Application Layer - Generator Sets and Industrial SAE J1939-81: Network Management	
Transmit/Receive Message	Maximum No. of Send Message	100		
	Maximum No. of Receive Message	200		
	Transmittable PGN	Optional		
	Maximum Length of Transmit/Receive Message	1 to 252 bytes/message		
Transmission Function	Transmission Type	Event transmission/periodical transmission		
	Event Transmission	Transmission Method	Internal relay	
		Cycle Transmission	Transmission Method	Internal relay
		Transmission Cycle (*1)	10 to 655,350 ms (in increments of 10ms)	
Receive Function	Receive Method	Polling reception (*2)		
	Receive Cycle Monitor	0, 10 to 655,350 ms (disabled at 0)		
Request Function	Yes			
Network Management Function	Static address/dynamic address management			
	NAME	Optional (automatic switching of static address /dynamic address management at highest-order bit)		
	Number of Nodes Manageable	128 nodes		
PGNs used Internally	00EA00h: Request PGN			
	00E800h: Acknowledgement			
	00EB00h: TP.DT			
	00EC00h: TP.CM			
	00EE00h: Address claim			

\*1) Message is transmitted in END processing. Actual transmission cycle is affected by the ladder execution cycle.

\*2) Receive message is transferred from internal buffer to data register in END processing.

## INPUT

Part Number	FC6A-C16R1AE FC6A-C16R1CE FC6A-C16P1CE FC6A-C16K1CE FC6A-C16R1DE FC6A-C16P1DE FC6A-C16K1DE	FC6A-C24R1AE FC6A-C24R1CE FC6A-C24P1CE FC6A-C24K1CE	FC6A-C40R1AE FC6A-C40R1CE FC6A-C40P1CE FC6A-C40K1CE FC6A-C40R1DE FC6A-C40P1DE FC6A-C40K1DE	FC6A-C40R1AEJ FC6A-C40R1CEJ FC6A-C40P1CEJ FC6A-C40K1CEJ FC6A-C40R1DEJ FC6A-C40P1DEJ FC6A-C40K1DEJ
Input Points	9 (9/1 common)	14 (14/1 common)	24 (24/1 common)	
Rated Input Voltage (*1)	AC, 24V DC power supply type: 24V DC sink/source input signal 12V DC power supply type: 12V DC sink/source input signal			
Input Voltage Range (*1)	AC, 24V DC power supply type: to 28.8V DC 12V DC power supply type: 0 to 18.0V DC			
Rated Input Current (*1)	AC, 24V DC power supply type: high speed input port 5mA/pt, middle/normal speed input port 7mA/pt 12V DC power supply type: high speed input port 5mA/pt, middle/normal speed input port 6mA/pt			
Input Impedance (*1)	AC, 24V DC power supply type: high speed input port 4.9kΩ, middle/normal speed input port: 3.4kΩ 12V DC power supply type: high speed input port 1.8kΩ, middle/normal speed input port: 2.0kΩ			
Input Delay	Turn ON Time	High speed input port: 5μs + filter value Middle speed input port: 35μs + filter value Normal speed input port: 35μs + filter value		
	Turn OFF Time	High speed input port: 5μs + filter value Middle speed input port: 35μs + filter value Normal speed input port: 100μs + filter value		
Isolation	Between input terminals: Not isolated Internal circuit: Optocoupler-isolated			
Input Type	Type1 (IEC 61131-2)			
External Load for I/O Interconnection	Not needed			
Signal Determination Method	Static			
Effect of Improper Input Connection	Both sinking and sourcing input signals can be connected, therefore reverse connection does not cause damage. If any input exceeding the rated value is applied, permanent damage may be caused.			
Cable Length	3m in compliance with electromagnetic immunity			
Connector	Insertion Durability	100 times		

\*1) 24V DC is for FC6A-C\*\*\*1CE and FC6A-C40\*1CEJ.  
12V DC is for FC6A-C\*\*\*1DE and FC6A-C40\*1DEJ.

## TRANSISTOR OUTPUT

Part Number	FC6A-C16P1CE FC6A-C16K1CE FC6A-C16P1DE FC6A-C16K1DE	FC6A-C24P1CE FC6A-C24K1CE	FC6A-C40P1CE FC6A-C40K1CE FC6A-C40P1DE FC6A-C40K1DE	FC6A-C40P1CEJ FC6A-C40K1CEJ FC6A-C40P1DEJ FC6A-C40K1DEJ
Transistor Output Points	7 (7/1 common)	10 (10/1 common)	16 (8/1 common)	
Output Type	Transistor Sink	FC6A-C16K1CE / FC6A-C16K1DE / FC6A-C24K1CE / FC6A-C40K1CE / FC6A-C40K1DE / FC6A-C40K1CEJ / FC6A-C40K1DEJ		
	Transistor Source	FC6A-C16P1CE / FC6A-C16P1DE / FC6A-C24P1CE / FC6A-C40P1CE / FC6A-C40P1DE / FC6A-C40P1CEJ / FC6A-C40P1DEJ		
Rated Load Voltage (*1)	24V DC power supply type: 24V DC 12V DC power supply type: 12V DC			
Voltage Tolerance (*1)	24V DC power supply type: 19.2 to 28.8V DC 12V DC power supply type: 10.2 to 18.0V DC			24V DC: 19.2 to 28.8V DC 12V DC: 10.2 to 16.0V DC
Rated Load Current	Per Point	0.5A		
	Per Common	3.5A	5A	4A
Output Delay	Turn ON Time	High speed input port: 5μs Middle speed input port: 30μs Normal speed input port: 300μs		High speed input port: 5μs Normal speed input port: 300μs
	Turn OFF Time	High speed input port: 5μs Middle speed input port: 30μs Normal speed input port: 300μs		High speed input port: 5μs Normal speed input port: 300μs
Isolation	Between output terminal and Internal circuit: Optocoupler-isolated Between output terminals: Not isolated			
Voltage Drop (ON Voltage)	1V max (voltage between COM and output terminal when output is on.)			
Inrush Current	1A			
Leakage Current	0.1mA maximum			
Clamping Voltage (*1)	24V DC power supply type: 39V ±1V 12V DC power supply type: 39V ±1V			24V DC: 39V ±1V 12V DC: 27V ±1V
Maximum Lamp Load	12W			
Inductive Load (*1)	24V DC power supply type: L/R=10ms (28.8V DC, 1Hz) 12V DC power supply type: FC6A-C16P1DE / FC6A-C16K1DE / FC6A-C40P1DE / FC6A-C40K1DE, L/R=10ms (18.0V DC 1Hz), FC6A-C40P1DEJ / FC6A-C40K1DEJ, L/R=10ms (16.0V DC, 1Hz)			
Overcurrent Protection	Transistor Sink Output: No Transistor Source Output: Overcurrent is detected by current limit resistance. (*2)			
External Current Draw (*1)	24V DC power supply type: 100mA maximum, 24V DC (power voltage at the +V terminal, -V terminal at source) 12V DC power supply type: 100mA maximum, 12V DC (power voltage at the +V terminal, -V terminal at source)			
Connector	Insertion Durability	100 times		

\*1) 24V DC is for FC6A-C\*\*\*1CE and FC6A-C40\*1CEJ.  
12V DC is for FC6A-C\*\*\*1DE and FC6A-C40\*1DEJ.

\*2) This overcurrent signals consist of one signal per 4 point outputs. When microprocessor gets this overcurrent signal by interrupt input, microprocessor turns off 4pt outputs of this category at fixed time (approx. 1sec).

## RELAY OUTPUT SPECIFICATIONS

Part Number		FC6A-C16R1AE FC6A-C16R1CE FC6A-C16R1DE	FC6A-C24R1AE FC6A-C24R1CE	FC6A-C40R1AE FC6A-C40R1CE FC6A-C40R1DE	FC6A-C40R1AEJ FC6A-C40R1CEJ FC6A-C40R1DEJ
Relay Output Points		7	10	16	
Output Points per Common Line	COM1	4	4	4	
	COM2	3	4	4	
	COM3	—	2	4	
	COM4	—	—	4	
Output Type		1NO			
Maximum Load Current	Per Point	2A			
	Per Common	COM1: 7A COM2: 6A	COM1: 7A COM2: 7A COM3: 4A	COM1: 7A COM2: 7A COM3: 7A COM4: 7A	
Minimum Switching Load		1mA/5V DC (reference value)			
Initial Contact Resistance		30 mΩ maximum			
Electrical Life		100,000 operations minimum (rated resistive load 1,800 operations/hour)			
Mechanical Life		20,000,000 operations minimum (no load 18,000 operations/hour)			
Rated Load		Resistive load: 240V AC 2A, 30V DC 2A Inductive load: 240V AC 2A (cos φ = 0.4), 30V DC 2A (L/R = 7 ms)			
Dielectric Strength		Between output and ground terminals: 2,300V AC, 1 minute Between output terminal and internal circuit: 2,300V AC, 1 minute Between output terminals (COMs): 2,300V AC, 1 minute			
Connector	Insertion/ Removal Durability	100 times			

## ALL-IN-ONE CPU MODULES

All dimensions in mm.

### 16 I/Os (8/8)

FC6A-C16R1AE  
FC6A-C16R1CE  
FC6A-C16R1DE  
FC6A-C16P1CE  
FC6A-C16P1DE  
FC6A-C16K1CE  
FC6A-C16K1DE

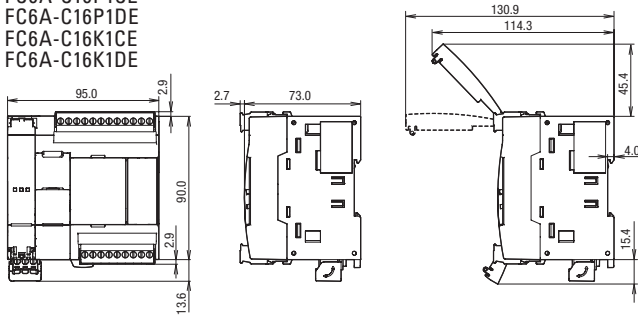

### 24 I/Os (14/10)

FC6A-C24R1AE  
FC6A-C24R1CE  
FC6A-C24P1CE  
FC6A-C24K1CE

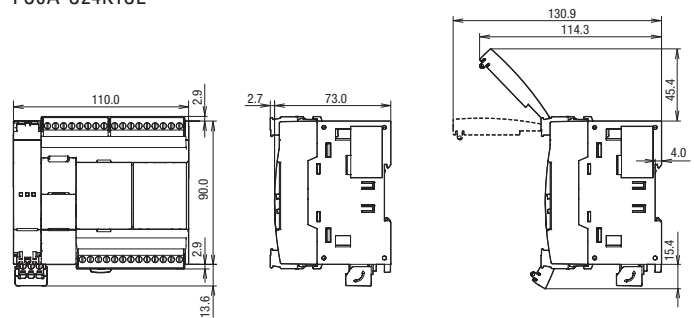

### 40 I/Os (24/16)

FC6A-C40R1AE  
FC6A-C40R1CE  
FC6A-C40P1CE  
FC6A-C40K1CE  
FC6A-C40R1DE  
FC6A-C40P1DE  
FC6A-C40K1DE

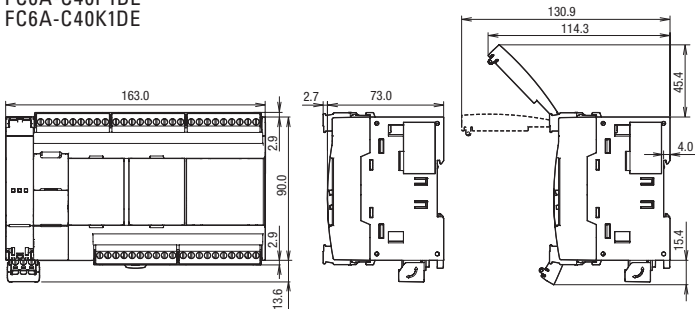

## CAN J1939 ALL-IN-ONE CPU MODULES

### 40 I/Os (24/16)

FC6A-C40R1AEJ  
FC6A-C40R1CEJ  
FC6A-C40P1CEJ  
FC6A-C40K1CEJ  
FC6A-C40R1DEJ  
FC6A-C40P1DEJ  
FC6A-C40K1DEJ

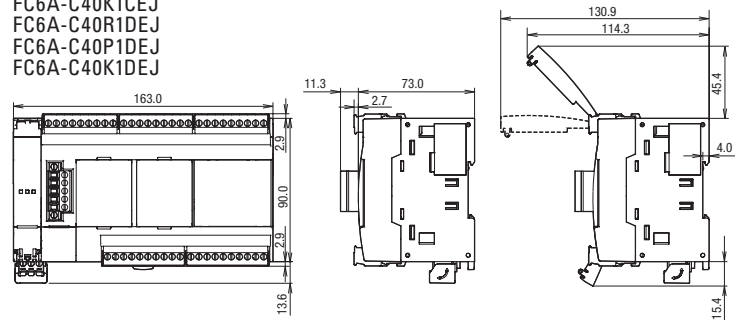

## TEMPERATURE DERATING CURVES: INPUT VOLTAGE VS. I/O SIMULTANEOUS ON RATIO (%)

### Plus CPU Module

#### Input

FC6A-D16P1CEE  
 FC6A-D16P4CEE  
 FC6A-D16K1CEE  
 FC6A-D16K4CEE  
 FC6A-D32P3CEE  
 FC6A-D32P4CEE  
 FC6A-D32K3CEE  
 FC6A-D32K4CEE

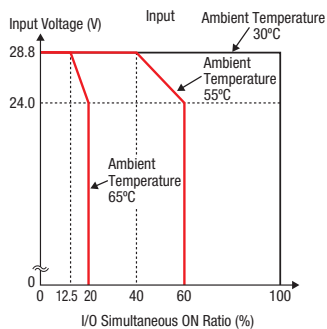

#### Output

FC6A-D16P1CEE  
 FC6A-D16P4CEE  
 FC6A-D16K1CEE  
 FC6A-D16K4CEE  
 FC6A-D32P3CEE  
 FC6A-D32P4CEE  
 FC6A-D32K3CEE  
 FC6A-D32K4CEE

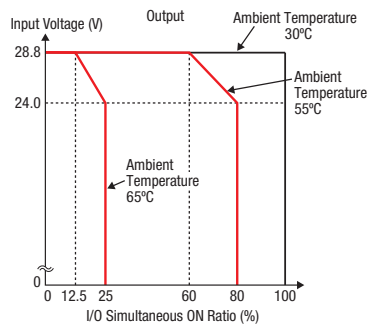

#### Input

FC6A-D16R1CEE  
 FC6A-D16R4CEE

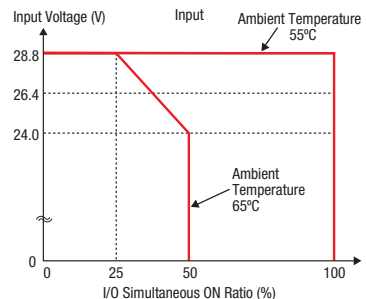

#### Output

FC6A-D16R1CEE  
 FC6A-D16R4CEE

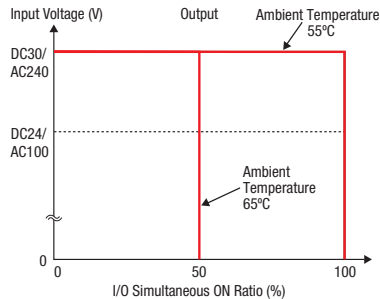

### All-in-One / CAN J1939 All-in-One CPU Module (without cartridge)

#### Input

FC6A-C16R1AE  
 FC6A-C16R1CE  
 FC6A-C24R1AE  
 FC6A-C24R1CE  
 FC6A-C40R1AE  
 FC6A-C40R1CE  
 FC6A-C40R1AEJ  
 FC6A-C40R1CEJ



#### Output

FC6A-C16R1AE  
 FC6A-C16R1CE  
 FC6A-C24R1AE  
 FC6A-C24R1CE  
 FC6A-C40R1AE  
 FC6A-C40R1CE  
 FC6A-C40R1AEJ  
 FC6A-C40R1CEJ

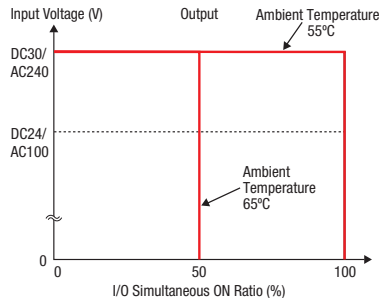

#### Input

FC6A-C16R1DE  
 FC6A-C40R1DE  
 FC6A-C40R1DEJ

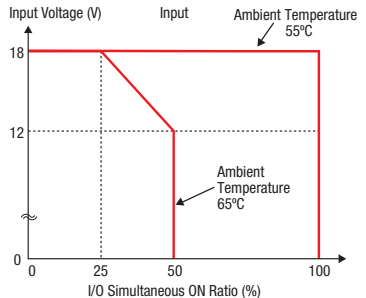

#### Output

FC6A-C16R1DE  
 FC6A-C40R1DE  
 FC6A-C40R1DEJ

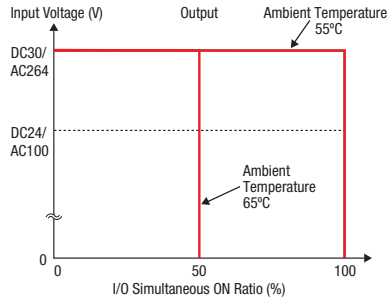

#### Input

FC6A-C16P1DE  
 FC6A-C24P1CE  
 FC6A-C40P1CE  
 FC6A-C40P1DE  
 FC6A-C40P1CEJ  
 FC6A-C40P1DEJ



#### Output

FC6A-C16P1DE  
 FC6A-C24P1CE  
 FC6A-C40P1CE  
 FC6A-C40P1DE  
 FC6A-C40P1CEJ  
 FC6A-C40P1DEJ

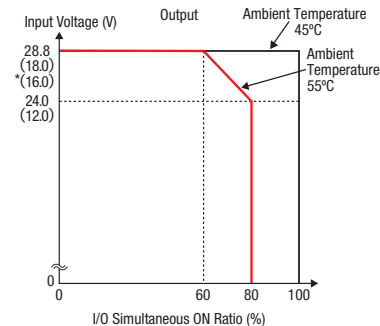

- Values in ( ) are for 12V DC model.
- Values shown in \* ( ) are for CAN J1939 All-in-One CPU module.

## All-in-One / CAN J1939 All-in-One CPU Module (with cartridge or when used under ambient temperature exceeding 55°C)

### Input

FC6A-C16P1DE FC6A-C40P1CEJ  
 FC6A-C24P1CE FC6A-C40P1DEJ  
 FC6A-C40P1CE  
 FC6A-C40P1DE

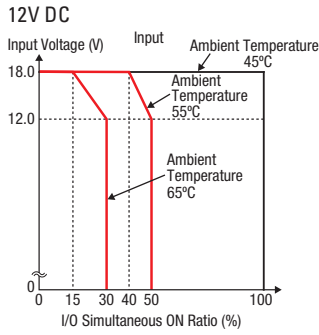
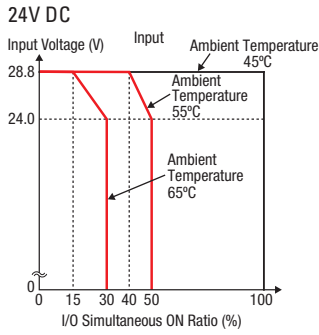

### Output

FC6A-C16P1DE FC6A-C40P1CEJ  
 FC6A-C24P1CE FC6A-C40P1DEJ  
 FC6A-C40P1CE  
 FC6A-C40P1DE

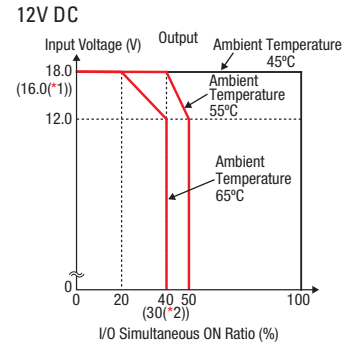
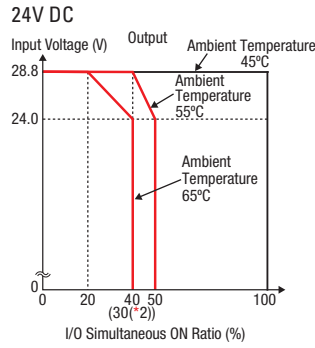

### Input

FC6A-C16K1CE FC6A-C40K1DE  
 FC6A-C16K1DE FC6A-C40K1CEJ  
 FC6A-C24K1CE FC6A-C40K1DEJ  
 FC6A-C40K1CE

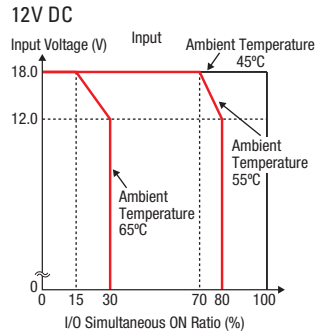
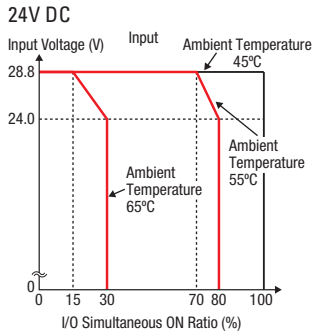

### Output

FC6A-C16K1CE FC6A-C40K1DE  
 FC6A-C16K1DE FC6A-C40K1CEJ  
 FC6A-C24K1CE FC6A-C40K1DEJ  
 FC6A-C40K1CE

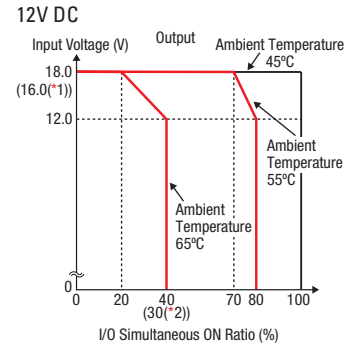
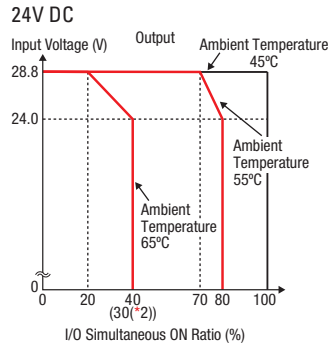

\*1) Values shown in ( ) are for CAN J1939 All-in-One CPU module.

\*2) Values shown in ( ) are for 16 I/O type All-in-One CPU module.

## INPUT INTERNAL CIRCUIT

100V to 240V AC, 24V DC, 12V DC

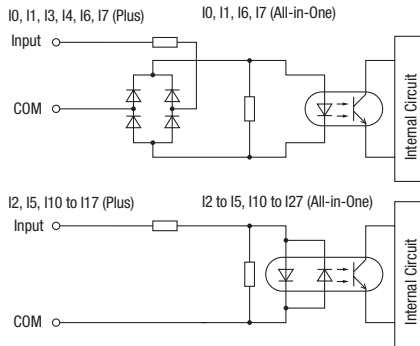

## OUTPUT INTERNAL CIRCUIT

Transistor Sink Output

24V DC, 12V DC

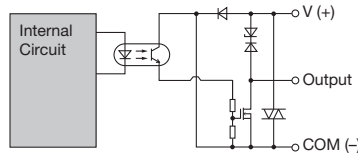

Transistor Source Output

24V DC, 12V DC

