

MicroSmart FC6A All-in-One PLC

CPU Module Specifications



PRODUCT DESCRIPTION

MicroSmart FC6A All-in-One, a powerful PLC with up to 520 digital I/O and 126 analog I/O. The MicroSmart FC6A provides the power of a PAC (programmable automation controller) in a low-cost controller with a small form factor, making it an ideal fit for demanding applications. Available in 12VDC, 24VDC, and 100-240VAC.

KEY FEATURES

- iOS and Android WindEDIT App
- Bluetooth communication
- Embedded Ethernet port
- Embedded SD memory port
- Modbus TCP and RTU
- Embedded RS232C/RS485 user selectable
- Maximum 520 digital I/O
- Maximum 126 analog I/O
- Data Logging
- Web Server Functions
- Large programming and data memory
- SAE J1939 CPU
- -25 to 65 degrees C operating temperature

STANDARD BASE MODULE

| Part Number | Total I/O | Power Voltage | Input Voltage | Output Type | Maximum Digital I/O | Maximum Analog I/O | |
|--------------|-------------------------------|-------------------|-----------------------|-----------------------|---------------------|--------------------|-------|
| FC6A-C16R1AE | 16 (9 inputs, 7 outputs) | 100-240V AC | 24V DC Sink/Source | Relay | 400 | 100 | |
| FC6A-C16R1CE | | 24V DC | | Relay | | | |
| FC6A-C16P1CE | | | | Transistor Source | | | |
| FC6A-C16K1CE | | | | Transistor Sink | | | |
| FC6A-C16R1DE | 16 (9 inputs, 7 outputs) | 12V DC | 12V DC Sink/Source | Relay | 152 | 36 | |
| FC6A-C16P1DE | | 24V DC | | Transistor Source | | | |
| FC6A-C16K1DE | | | | Transistor Sink | | | |
| FC6A-C24R1AE | | | | 100-240V AC | | | Relay |
| FC6A-C24R1CE | 24V DC | Relay | | | | | |
| FC6A-C24P1CE | | Transistor Source | | | | | |
| FC6A-C24K1CE | | Transistor Sink | | | | | |
| FC6A-C40R1AE | 40 (24 inputs, 16 outputs) | 100-240V AC | 24V DC Sink/Source | Relay | 520 | 126 | |
| FC6A-C40R1CE | | 24V DC | | Relay | | | |
| FC6A-C40P1CE | | | | Transistor Source | | | |
| FC6A-C40K1CE | | | | Transistor Sink | | | |
| FC6A-C40R1DE | | 12V DC | | 12V DC Sink/Source | Relay | 40 | 6 |
| FC6A-C40P1DE | | | | | Transistor Source | | |
| FC6A-C40K1DE | | | | | Transistor Sink | | |

CAN J1939 BASE MODULE

| Part Number | Total I/O | Power Voltage | Input Voltage | Output Type | Maximum Digital I/O | Maximum Analog I/O | | | |
|---------------|-------------------------------|---------------|-----------------------|-----------------------|---------------------|--------------------|-------------------|--|--|
| FC6A-C40R1AEJ | 40 (24 inputs, 16 outputs) | 100-240V AC | 24V DC Sink/Source | Relay | 250 | 126 | | | |
| FC6A-C40R1CEJ | | 24V DC | | Relay | | | | | |
| FC6A-C40P1CEJ | | | | Transistor Source | | | | | |
| FC6A-C40K1CEJ | | | | Transistor Sink | | | | | |
| FC6A-C40R1DEJ | | 12V DC | | 12V DC Sink/Source | | | Relay | | |
| FC6A-C40P1DEJ | | | | | | | Transistor Source | | |
| FC6A-C40K1DEJ | | | | | | | Transistor Sink | | |



SPECIFICATIONS

| | | | | |
|--|--|--|--|--|
| Part Number | FC6A-C16R1AE FC6A-C16R1CE FC6A-C16P1CE FC6A-C16K1CE FC6A-C16R1DE FC6A-C16P1DE FC6A-C16K1DE | FC6A-C24R1AE FC6A-C24R1CE FC6A-C24P1CE FC6A-C24K1CE | FC6A-C40R1AE FC6A-C40R1CE FC6A-C40P1CE FC6A-C40K1CE FC6A-C40R1DE FC6A-C40P1DE FC6A-C40K1DE | FC6A-C40R1AEJ FC6A-C40R1CEJ FC6A-C40P1CEJ FC6A-C40K1CEJ FC6A-C40R1DEJ FC6A-C40P1DEJ FC6A-C40K1DEJ |
| Rated Power Voltage | AC: 100 to 240V AC, DC: 24V DC, 12V DC | | | |
| Allowable Voltage Range | AC: 85 to 264V AC 24V DC: 20.4 to 28.8V DC (including ripple), 12V DC: 10.2 to 18.0V | | | |
| Rated Frequency | AC: 50/60Hz (47 to 63 Hz) | | | |
| Maximum Power Consumption (CPU module) | AC | FC6A-C16R1AE: 100-240V AC, 33VA FC6A-C24R1AE: 100-240V AC, 35VA | | FC6A-C40R1AE: 100-240V AC, 41VA FC6A-C40R1AEJ: 100-240V AC, 37VA |
| | DC | FC6A-C16R1CE: 24V DC 140mA, 3.36W FC6A-C24R1CE: 24V DC 155mA, 3.72W FC6A-C40R1CE: 24V DC 195mA, 4.68W FC6A-C16P1CE: 24V DC 190mA, 4.6W FC6A-C24P1CE: 24V DC 200mA, 4.8W FC6A-C40P1CE: 24V DC 205mA, 5.0W FC6A-C16K1CE: 24V DC 190mA, 4.6W FC6A-C24K1CE: 24V DC 200mA, 4.8W | | FC6A-C40K1CE: 24V DC 205mA, 5.0W FC6A-C16R1DE: 12V DC 270mA, 3.24W FC6A-C40R1DE: 12V DC 345mA, 4.14W FC6A-C16P1DE: 12V DC 260mA, 3.12W FC6A-C40P1DE: 12V DC 260mA, 3.12W FC6A-C16K1DE: 12V DC 250mA, 3.0W FC6A-C40K1DE: 12V DC 260mA, 3.12W FC6A-C40R1CEJ: 24V DC 205mA, 5.0W FC6A-C40P1CEJ: 24V DC 175mA, 4.2W FC6A-C40K1CEJ: 24V DC 175mA, 4.2W FC6A-C40R1DEJ: 12V DC 340mA, 4.08W FC6A-C40P1DEJ: 12V DC 320mA, 3.9W FC6A-C40K1DEJ: 12V DC 320mA, 3.9W |
| Inrush Current | AC: 40A maximum 24V DC: 35A maximum 12V DC: 35A maximum | | | |
| Allowable Momentary Power Interruption | 10 ms (at rated voltage) | | | |
| Dielectric Strength | AC | Between power and PE terminals: 1,500V AC, 1 minute Between relay output and PE terminals: 2,300V AC, 1 minute Between power and relay output terminals: 2,300V AC, 1 minute | | Between input and PE terminals: 1,500V AC, 1 minute Between power and input terminals: 1,500V AC, 1 minute Between input and relay output terminals: 2,300V AC, 1 minute |
| | DC | Between power and FE terminals: 500V AC, 1 minute Between transistor output and FE terminals: 500V AC, 1 minute Between power and input terminals: 500V AC, 1 minute Between power and relay output terminals: 2,300V AC, 1 minute Between input and relay output terminals: 2,300V AC, 1 minute | | Between input and FE terminals: 500V AC, 1 minute Between relay output and FE terminals: 2,300V AC, 1 minute Between power and transistor output terminals: 500V AC, 1 minute Between input and transistor output terminals: 500V AC, 1 minute |
| Insulation Resistance | AC | Between power and PE terminals: 100 MΩ or higher (500V DC megger) Between relay output and PE terminals: 100 MΩ or higher (500V DC megger) Between power and relay output terminals: 100 MΩ or higher (500V DC megger) | | Between input and PE terminals: 100 MΩ or higher (500V DC megger) Between power and input terminals: 100 MΩ or higher (500V DC megger) Between input and relay output terminals: 100 MΩ or higher (500V DC megger) |
| | DC | Between power and FE terminals: 100 MΩ or higher (500V DC megger) Between transistor output and FE terminals: 100 MΩ or higher (500V DC megger) Between power and input terminals: 100 MΩ or higher (500V DC megger) Between power and relay output terminals: 100 MΩ or higher (500V DC megger) Between input and relay output terminals: 100 MΩ or higher (500V DC megger) | | Between input and FE terminals: 100 MΩ or higher (500V DC megger) Between relay output and PE terminals: 100 MΩ or higher (500V DC megger) Between power and transistor output terminals: 100 MΩ or higher (500V DC megger) Between input and transistor output terminals: 100 MΩ or higher (500V DC megger) |
| Power Supply Wire | UL1007 AWG24-16, UL2464 AWG24-16, UL1015 AWG20-16 | | | |
| Grounding Wire | UL1007, AWG16 | | | |
| Ground | D-type ground (Class 3 ground) | | | |
| Mounting | DIN rail or panel mounting | | | |
| Weight | FC6A-C16R1AE: 370g FC6A-C16R1CE: 350g FC6A-C16P1CE: 340g FC6A-C16K1CE: 340g FC6A-C16R1DE: 350g FC6A-C16P1DE: 340g FC6A-C16K1DE: 340g | FC6A-C24R1AE: 420g FC6A-C24R1CE: 400g FC6A-C24P1CE: 380g FC6A-C24K1CE: 380g | FC6A-C40R1AE: 560g FC6A-C40R1CE: 530g FC6A-C40P1CE: 480g FC6A-C40K1CE: 480g FC6A-C40R1DE: 560g FC6A-C40P1DE: 530g FC6A-C40K1DE: 530g | FC6A-C40R1AEJ: 560g FC6A-C40R1CEJ: 530g FC6A-C40P1CEJ: 480g FC6A-C40K1CEJ: 480g FC6A-C40R1DEJ: 560g FC6A-C40P1DEJ: 530g FC6A-C40K1DEJ: 530g |

Note: For operating conditions, see page 8.

FUNCTION SPECIFICATIONS

| | | | | |
|--|--|---|--|---|
| Part Number | FC6A-C16R1AE FC6A-C16R1CE FC6A-C16P1CE (*5) FC6A-C16K1CE (*5) FC6A-C16R1DE FC6A-C16P1DE (*5) FC6A-C16K1DE (*5) | FC6A-C24R1AE FC6A-C24R1CE FC6A-C24P1CE (*5) FC6A-C24K1CE (*5) | FC6A-C40R1AE FC6A-C40R1CE FC6A-C40P1CE (*5) FC6A-C40K1CE (*5) FC6A-C40R1DE FC6A-C40P1DE (*5) FC6A-C40K1DE (*5) | FC6A-C40R1AEJ FC6A-C40R1CEJ FC6A-C40P1CEJ (*5) FC6A-C40K1CEJ (*5) FC6A-C40R1DEJ FC6A-C40P1DEJ (*5) FC6A-C40K1DEJ (*5) |
| Control System | Stored program system | | | |
| Instruction Words | Basic | 42 | | |
| | Advanced | 129 | | |
| Program Capacity (*1) | 384KB (48,000 steps)/72KB (9,000 steps) (*2) | | | 640KB (80,000 steps) 72KB (9,000 steps) (*2) |
| User Program Download | 1,000 times | | | |
| Processing Time | Basic Instruction | 42µs/1,000 steps | | |
| | END Processing (*3) | 1ms maximum | | |
| I/O Points | Input | 9 points | 14 points | 24 points |
| | Output | 7 points | 10 points | 16 points |
| Expandable Modules | 4 modules | | 7 modules | |
| Expandable I/O Points with Expansion Modules | 128 points | | 224 points | |
| Expandable Modules with Unibody Type | 8 modules | | | |
| Expansion Interface Modules | 256 points | | | |
| Expandable I/O Points with Expansion Interface Modules | 12,400 points | | | |
| Internal Relay | 256 points | | | |
| Special Internal Relay | 256 points | | | |
| Shift Register | 54,000 points | | | |
| Data Register | 500 points | | | |
| Special Data Register | 512 points | | | |
| Counter | 1,024 points | | | |
| Timer (1ms, 10ms, 100ms, 1s) | Clock accuracy: ±30 sec/month (typical) at 25°C | | | |
| RAM Backup | Backup Data | RAM (internal relay, shift register, counter, data register), clock data (*9) | | |
| | Battery (enclosed with products) | Lithium primary battery (part number of enclosed batteries cannot be selected) Panasonic: BR2032 / CR2032A / CR2032B Murata: CR2032X / CR2032W | | |
| | Battery Life | 1-year warranty (replacement approx. 4 years (+25°C)) (*10) | | |
| | Replaceability | Replace within one minute after power off (recommended) (*6) | | |
| Self-diagnostic Function | Keep data, user program (ROM) CRC check, timer/counter preset value change check, user program syntax check, user program execution check, watchdog timer check, user program download check, power failure, clock error, data link connection check, expansion bus initialization check, system check, SD memory card transfer check, SD memory card access check | | | |
| Input Filter | 0 ms (without filter), 3 to 15ms (selectable in increments of 1ms) | | | |
| Catch Input/Interrupt Input | Six inputs I0, I1, I6, I7 (Minimum turn on pulse width: 5µs max., Minimum turn off pulse width: 5µs max.) I3, I4 (Minimum turn on pulse width: 35µs max., Minimum turn off pulse width: 35µs max.) | | | |
| High-speed Counter | Maximum Counting Frequency and High-speed Counter Points | Total 6 points Single/two-phase selectable: 100 kHz (single-phase: 4 points, two-phase: 2 points) Single-phase: 5 kHz (2 points) | | |
| | Counting Range | 0 to 4,294,967,295 (32 bits) | | |
| | Operation Mode | Rotary encoder mode, adding counter mode, frequency measurement mode | | |
| Analog Potentiometer | Quantity | 1 point | | |
| | Data Range | 0 to 1,000 | | |
| Analog Voltage Input | Quantity | 1 point | | |
| | Input Voltage Range | 0 to 10V | | |
| | Input Impedance | Approx. 100KΩ | | |
| | Digital Resolution | Approx. 1,000 steps (10 bits) | | |
| Pulse Output (transistor output model only) | Quantity | 4 points | | |
| | Maximum Output Pulse Frequency | Q0, Q1: 100 kHz | Q2, Q3: 5 kHz | Q0, Q2, Q4, Q6: 100 kHz |
| | Reversible Control | Single-pulse output mode: 2 axis (Q0-Q3) Dual-pulse output mode: 1 axis (Q0-Q1) | | |
| | PWM Output | Duty cycle 0.1 to 100.0% (increments of 0.1%) Output pulse frequency 15 to 5,000 (increments of 1 Hz): 4 points (Q0-Q3) *Q0, Q1: Adjust 5µs minimum as ON time and 15µs minimum as OFF time. *Q2, Q3: Adjust 100µs minimum as ON/OFF time. | | |
| | | Single-pulse output mode: 4 axis (Q0-Q7) Dual-pulse output mode: 4 axis (Q0-Q7) Dual cycle: 0.1 to 100.0% (increments of 0.1%) Output pulse frequency: 15 to 5,000 (increments of 1 Hz): 4 points (Q0, Q2, Q4, Q6) * Adjust 5µs minimum as ON time and 15µs minimum as OFF time. | | |
| External Power Supply for Sensor (*8) (AC only) | Output Voltage/Current | 24V (+10%, -15%) / 250mA | | |
| | Overload Detection Isolation from the internal circuit | Not possible Transformer-isolated | | |
| USB Port | USB mini-B (maintenance communication) | | | |
| Serial Port 1, CAN Port | RS232C or RS485 (*4) | | | CAN J1939 |
| Ethernet Port 1 | Ethernet (maintenance communication, user communication, Modbus TCP server/client) | | | |
| SD Card Slot | Embedded (*7) | | | |
| Cartridge (option) (*8) | One cartridge can be added on CPU module | | Two cartridges can be added on CPU module | |
| | One cartridge can be added on HMI module (FC6A-PH1) | | One cartridge can be added on HMI module (FC6A-PH1) | |
| HMI Module (option) (*8) | Yes | Yes | Yes | Yes |

*1) 1 step equals 8 bytes. *2) When 72KB is selected, download function can be used during RUN.

*3) Not including expansion I/O service time, counter timer processing time, data link processing time, and interrupt processing time.

*4) Maintenance communication, user communication, data link, Modbus RTU master/slave communication. *5) Transistor output model

*6) Batteries can be replaced when power is on or replaced while power is supplied from USB bus power *7) SD memory cards (max 2 GB), SDHC memory cards (max 32 GB)

*8) External power supplies for sensor, cartridges and HMI Modules cannot be used under the expanded ambient operating temperature (-25 to -10°C, +55 to +65°C).

*9) RAM backup data can be saved in a non-volatile memory using the SD card receipt function.

*10) 1-year warranty conditions include operating environments (temperature/humidity) during power off and power on.

Note: The maximum number of relay outputs that can be turned on simultaneously is limited. The upper limit varies on the expanded ambient operating temperature (-25 to -10°C, +55 to +65°C).

USB PORT SPECIFICATIONS

| | | | | |
|------------------------|--|--|--|---|
| Part Number | FC6A-C16R1AE FC6A-C16R1CE FC6A-C16P1CE FC6A-C16K1CE FC6A-C16R1DE FC6A-C16P1DE FC6A-C16K1DE | FC6A-C24R1AE FC6A-C24R1CE FC6A-C24P1CE FC6A-C24K1CE | FC6A-C40R1AE FC6A-C40R1CE FC6A-C40P1CE FC6A-C40K1CE FC6A-C40R1DE FC6A-C40P1DE FC6A-C40K1DE | FC6A-C40R1AEJ FC6A-C40R1CEJ FC6A-C40P1CEJ FC6A-C40K1CEJ FC6A-C40R1DEJ FC6A-C40P1DEJ FC6A-C40K1DEJ |
| USB Type | USB mini-B | | | |
| USB Standard | USB 2.0 full speed | | | |
| Isolation | Not isolated from the internal circuit | | | |
| Communication Function | Maintenance communication to PC | | | |

SERIAL PORT 1, CAN PORT

| | | | | |
|------------------------|--|--|--|---|
| Part Number | FC6A-C16R1AE FC6A-C16R1CE FC6A-C16P1CE FC6A-C16K1CE FC6A-C16R1DE FC6A-C16P1DE FC6A-C16K1DE | FC6A-C24R1AE FC6A-C24R1CE FC6A-C24P1CE FC6A-C24K1CE | FC6A-C40R1AE FC6A-C40R1CE FC6A-C40P1CE FC6A-C40K1CE FC6A-C40R1DE FC6A-C40P1DE FC6A-C40K1DE | FC6A-C40R1AEJ FC6A-C40R1CEJ FC6A-C40P1CEJ FC6A-C40K1CEJ FC6A-C40R1DEJ FC6A-C40P1DEJ FC6A-C40K1DEJ |
| Port Type | Serial port 1 | | | CAN port |
| Communication Type | RS232C or RS485 selectable | | | CAN |
| Connector | RJ45 | | | Terminal Block (5-pin) |
| Cable | CAT. 5 or higher STP | | | SAE J1939-11/SAE J1939-15 |
| Maximum Baud Rate | 115,200 bps | | | SAE J1939-11: 250 kbps: 40m, stubs, 1m maximum |
| Maximum Cable Length | RS232C: 5m, RS485: 200m | | | SAE J1939-15: 250 kbps: 40m, stubs, 3m maximum |
| Isolation | Not isolated from the internal circuit | | | Isolated from the internal circuit |
| Communication Function | Maintenance communication, user communication, Modbus RTU (master/slave) | | | J1939 |

ETHERNET PORT 1

| | | | | |
|------------------------|--|--|--|---|
| Part Number | FC6A-C16R1AE FC6A-C16R1CE FC6A-C16P1CE FC6A-C16K1CE FC6A-C16R1DE FC6A-C16P1DE FC6A-C16K1DE | FC6A-C24R1AE FC6A-C24R1CE FC6A-C24P1CE FC6A-C24K1CE | FC6A-C40R1AE FC6A-C40R1CE FC6A-C40P1CE FC6A-C40K1CE FC6A-C40R1DE FC6A-C40P1DE FC6A-C40K1DE | FC6A-C40R1AEJ FC6A-C40R1CEJ FC6A-C40P1CEJ FC6A-C40K1CEJ FC6A-C40R1DEJ FC6A-C40P1DEJ FC6A-C40K1DEJ |
| Communication Type | IEEE802.3 compliant | | | |
| Data Transfer | 10BASE-T, 100BASE-TX | | | |
| Connector | RJ45 | | | |
| Cable | CAT. 5 or higher STP | | | |
| Maximum Cable Length | 100m | | | |
| Isolation | Pulse transformer isolation | | | |
| Communication Function | Maintenance communication server, User communication (server/client), Modbus TCP (server/client), PING, SNTP | | | |

CAN J1939

| | | | | |
|-----------------------------|---|---|---|---------------|
| Part Number | FC6A-C40P1CEJ FC6A-C40P1DEJ | FC6A-C40K1CEJ FC6A-C40K1DEJ | FC6A-C40R1AEJ FC6A-C40R1DEJ | FC6A-C40R1CEJ |
| Supported SAE J1939 | SAE J1939-11: Physical Layer, 250K bits/s, Twisted Shielded Pair SAE J1939-15: Reduced Physical Layer, 250K bits/s, Unshielded Twisted Pair SAE J1939-21: Data Link Layer | | SAE J1939-71: Vehicle Application Layer SAE J1939-73: Application Layer - Diagnostics SAE J1939-75: Application Layer - Generator Sets and Industrial SAE J1939-81: Network Management | |
| Transmit/Receive Message | Maximum No. of Send Message | 100 | | |
| | Maximum No. of Receive Message | 200 | | |
| | Transmittable PGN | Optional | | |
| | Maximum Length of Transmit/Receive Message | 1 to 252 bytes/message | | |
| Transmission Function | Transmission Type | Event transmission/periodical transmission | | |
| | Event Transmission | Transmission Method | Internal relay | |
| | | Transmission Method | Internal relay | |
| Cycle Transmission | Transmission Cycle (*1) | 10 to 655,350 ms (in increments of 10ms) | | |
| Receive Function | Receive Method | Polling reception (*2) | | |
| | Receive Cycle Monitor | 0, 10 to 655,350 ms (disabled at 0) | | |
| Request Function | Yes | | | |
| Network Management Function | Static address/dynamic address management | | | |
| | NAME | Optional (automatic switching of static address /dynamic address management at highest-order bit) | | |
| | Number of Nodes Manageable | 128 nodes | | |
| PGNs used Internally | 00EA00h: Request PGN | | | |
| | 00E800h: Acknowledgement | | | |
| | 00EB00h: TP.DT | | | |
| | 00EC00h: TP.CM | | | |
| 00EE00h: Address claim | | | | |

*1) Message is transmitted in END processing. Actual transmission cycle is affected by the ladder execution cycle.

*2) Receive message is transferred from internal buffer to data register in END processing.

INPUT

| | | | | |
|---------------------------------------|---|--|--|---|
| Part Number | FC6A-C16R1AE FC6A-C16R1CE FC6A-C16P1CE FC6A-C16K1CE FC6A-C16R1DE FC6A-C16P1DE FC6A-C16K1DE | FC6A-C24R1AE FC6A-C24R1CE FC6A-C24P1CE FC6A-C24K1CE | FC6A-C40R1AE FC6A-C40R1CE FC6A-C40P1CE FC6A-C40K1CE FC6A-C40R1DE FC6A-C40P1DE FC6A-C40K1DE | FC6A-C40R1AEJ FC6A-C40R1CEJ FC6A-C40P1CEJ FC6A-C40K1CEJ FC6A-C40R1DEJ FC6A-C40P1DEJ FC6A-C40K1DEJ |
| Input Points | 9 (9/1 common) | 14 (14/1 common) | 24 (24/1 common) | |
| Rated Input Voltage (*1) | AC, 24V DC power supply type: 24V DC sink/source input signal 12V DC power supply type: 12V DC sink/source input signal | | | |
| Input Voltage Range (*1) | AC, 24V DC power supply type: to 28.8V DC 12V DC power supply type: 0 to 18.0V DC | | | |
| Rated Input Current (*1) | AC, 24V DC power supply type: high speed input port 5mA/pt, middle/normal speed input port 7mA/pt 12V DC power supply type: high speed input port 5mA/pt, middle/normal speed input port 6mA/pt | | | |
| Input Impedance (*1) | AC, 24V DC power supply type: high speed input port 4.9kΩ, middle/normal speed input port: 3.4kΩ 12V DC power supply type: high speed input port 1.8kΩ, middle/normal speed input port: 2.0kΩ | | | |
| Input Delay | Turn ON Time | High speed input port: 5μs + filter value Middle speed input port: 35μs + filter value Normal speed input port: 35μs + filter value | | |
| | Turn OFF Time | High speed input port: 5μs + filter value Middle speed input port: 35μs + filter value Normal speed input port: 100μs + filter value | | |
| Isolation | Between input terminals: Not isolated Internal circuit: Optocoupler-isolated | | | |
| Input Type | Type1 (IEC 61131-2) | | | |
| External Load for I/O Interconnection | Not needed | | | |
| Signal Determination Method | Static | | | |
| Effect of Improper Input Connection | Both sinking and sourcing input signals can be connected, therefore reverse connection does not cause damage. If any input exceeding the rated value is applied, permanent damage may be caused. | | | |
| Cable Length | 3m in compliance with electromagnetic immunity | | | |
| Connector | Insertion Durability | 100 times | | |

*1) 24V DC is for FC6A-C***1CE and FC6A-C40*1CEJ.
12V DC is for FC6A-C***1DE and FC6A-C40*1DEJ.

TRANSISTOR OUTPUT

| | | | | |
|----------------------------|--|--|--|--|
| Part Number | FC6A-C16P1CE FC6A-C16K1CE FC6A-C16P1DE FC6A-C16K1DE | FC6A-C24P1CE FC6A-C24K1CE | FC6A-C40P1CE FC6A-C40K1CE FC6A-C40P1DE FC6A-C40K1DE | FC6A-C40P1CEJ FC6A-C40K1CEJ FC6A-C40P1DEJ FC6A-C40K1DEJ |
| Transistor Output Points | 7 (7/1 common) | 10 (10/1 common) | 16 (8/1 common) | |
| Output Type | Transistor Sink | FC6A-C16K1CE / FC6A-C16K1DE / FC6A-C24K1CE / FC6A-C40K1CE / FC6A-C40K1DE / FC6A-C40K1CEJ / FC6A-C40K1DEJ | | |
| | Transistor Source | FC6A-C16P1CE / FC6A-C16P1DE / FC6A-C24P1CE / FC6A-C40P1CE / FC6A-C40P1DE / FC6A-C40P1CEJ / FC6A-C40P1DEJ | | |
| Rated Load Voltage (*1) | 24V DC power supply type: 24V DC 12V DC power supply type: 12V DC | | | |
| Voltage Tolerance (*1) | 24V DC power supply type: 19.2 to 28.8V DC 12V DC power supply type: 10.2 to 18.0V DC | | | 24V DC: 19.2 to 28.8V DC 12V DC: 10.2 to 16.0V DC |
| Rated Load Current | Per Point | 0.5A | | |
| | Per Common | 3.5A | 5A | 4A |
| Output Delay | Turn ON Time | High speed input port: 5μs Middle speed input port: 30μs Normal speed input port: 300μs | | High speed input port: 5μs Normal speed input port: 300μs |
| | Turn OFF Time | High speed input port: 5μs Middle speed input port: 30μs Normal speed input port: 300μs | | High speed input port: 5μs Normal speed input port: 300μs |
| Isolation | Between output terminal and Internal circuit: Optocoupler-isolated Between output terminals: Not isolated | | | |
| Voltage Drop (ON Voltage) | 1V max (voltage between COM and output terminal when output is on.) | | | |
| Inrush Current | 1A | | | |
| Leakage Current | 0.1mA maximum | | | |
| Clamping Voltage (*1) | 24V DC power supply type: 39V ±1V 12V DC power supply type: 39V ±1V | | | 24V DC: 39V ±1V 12V DC: 27V ±1V |
| Maximum Lamp Load | 12W | | | |
| Inductive Load (*1) | 24V DC power supply type: L/R=10ms (28.8V DC, 1Hz) 12V DC power supply type: FC6A-C16P1DE / FC6A-C16K1DE / FC6A-C40P1DE / FC6A-C40K1DE, L/R=10ms (18.0V DC 1Hz), FC6A-C40P1DEJ / FC6A-C40K1DEJ, L/R=10ms (16.0V DC, 1Hz) | | | |
| Overcurrent Protection | Transistor Sink Output: No Transistor Source Output: Overcurrent is detected by current limit resistance. (*2) | | | |
| External Current Draw (*1) | 24V DC power supply type: 100mA maximum, 24V DC (power voltage at the +V terminal, -V terminal at source) 12V DC power supply type: 100mA maximum, 12V DC (power voltage at the +V terminal, -V terminal at source) | | | |
| Connector | Insertion Durability | 100 times | | |

*1) 24V DC is for FC6A-C***1CE and FC6A-C40*1CEJ.
12V DC is for FC6A-C***1DE and FC6A-C40*1DEJ.

*2) This overcurrent signals consist of one signal per 4 point outputs. When microprocessor gets this overcurrent signal by interrupt input, microprocessor turns off 4pt outputs of this category at fixed time (approx. 1sec).

RELAY OUTPUT SPECIFICATIONS

| Part Number | | FC6A-C16R1AE FC6A-C16R1CE FC6A-C16R1DE | FC6A-C24R1AE FC6A-C24R1CE | FC6A-C40R1AE FC6A-C40R1CE FC6A-C40R1DE | FC6A-C40R1AEJ FC6A-C40R1CEJ FC6A-C40R1DEJ |
|-------------------------------|----------------------------------|---|----------------------------------|--|---|
| Relay Output Points | | 7 | 10 | 16 | |
| Output Points per Common Line | COM1 | 4 | 4 | 4 | |
| | COM2 | 3 | 4 | 4 | |
| | COM3 | — | 2 | 4 | |
| | COM4 | — | — | 4 | |
| Output Type | | 1NO | | | |
| Maximum Load Current | Per Point | 2A | | | |
| | Per Common | COM1: 7A COM2: 6A | COM1: 7A COM2: 7A COM3: 4A | COM1: 7A COM2: 7A COM3: 7A COM4: 7A | |
| Minimum Switching Load | | 1mA/5V DC (reference value) | | | |
| Initial Contact Resistance | | 30 mΩ maximum | | | |
| Electrical Life | | 100,000 operations minimum (rated resistive load 1,800 operations/hour) | | | |
| Mechanical Life | | 20,000,000 operations minimum (no load 18,000 operations/hour) | | | |
| Rated Load | | Resistive load: 240V AC 2A, 30V DC 2A Inductive load: 240V AC 2A (cos φ = 0.4), 30V DC 2A (L/R = 7 ms) | | | |
| Dielectric Strength | | Between output and ground terminals: 2,300V AC, 1 minute Between output terminal and internal circuit: 2,300V AC, 1 minute Between output terminals (COMs): 2,300V AC, 1 minute | | | |
| Connector | Insertion/ Removal Durability | 100 times | | | |

ALL-IN-ONE CPU MODULES

All dimensions in mm.

16 I/Os (8/8)

FC6A-C16R1AE
FC6A-C16R1CE
FC6A-C16R1DE
FC6A-C16P1CE
FC6A-C16P1DE
FC6A-C16K1CE
FC6A-C16K1DE

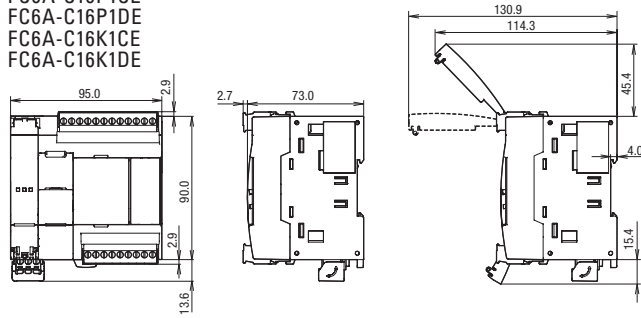

24 I/Os (14/10)

FC6A-C24R1AE
FC6A-C24R1CE
FC6A-C24P1CE
FC6A-C24K1CE

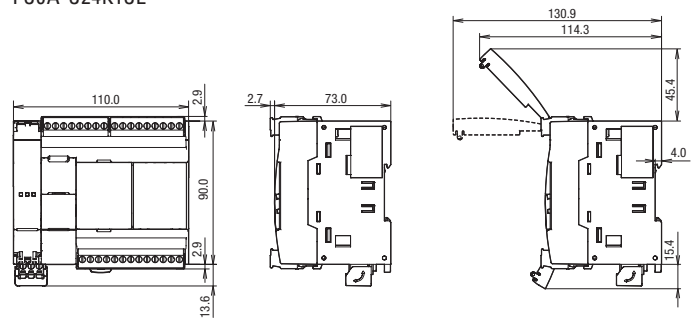

40 I/Os (24/16)

FC6A-C40R1AE
FC6A-C40R1CE
FC6A-C40P1CE
FC6A-C40K1CE
FC6A-C40R1DE
FC6A-C40P1DE
FC6A-C40K1DE

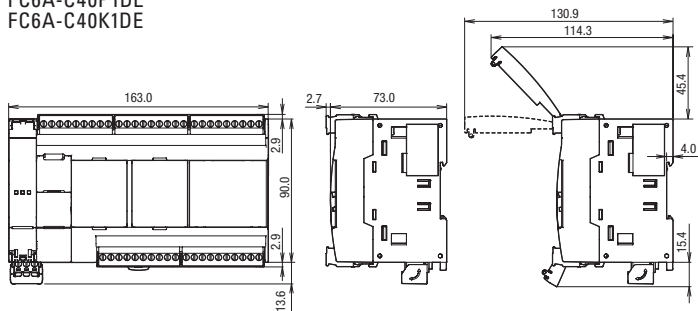

CAN J1939 ALL-IN-ONE CPU MODULES

40 I/Os (24/16)

FC6A-C40R1AEJ
FC6A-C40R1CEJ
FC6A-C40P1CEJ
FC6A-C40K1CEJ
FC6A-C40R1DEJ
FC6A-C40P1DEJ
FC6A-C40K1DEJ

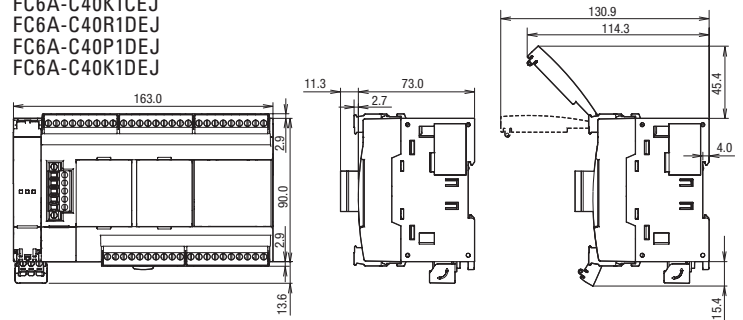

TEMPERATURE DERATING CURVES: INPUT VOLTAGE VS. I/O SIMULTANEOUS ON RATIO (%)

Plus CPU Module

Input

FC6A-D16P1CEE
 FC6A-D16P4CEE
 FC6A-D16K1CEE
 FC6A-D16K4CEE
 FC6A-D32P3CEE
 FC6A-D32P4CEE
 FC6A-D32K3CEE
 FC6A-D32K4CEE

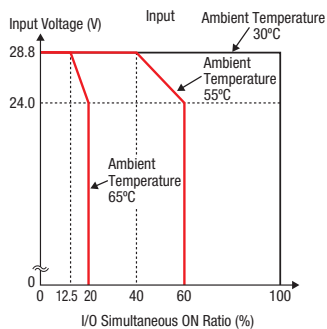

Output

FC6A-D16P1CEE
 FC6A-D16P4CEE
 FC6A-D16K1CEE
 FC6A-D16K4CEE
 FC6A-D32P3CEE
 FC6A-D32P4CEE
 FC6A-D32K3CEE
 FC6A-D32K4CEE

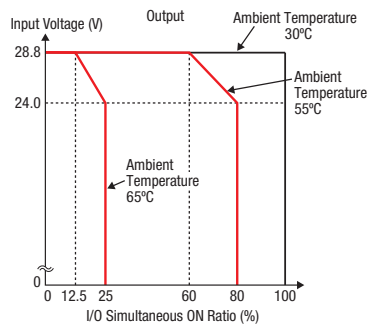

Input

FC6A-D16R1CEE
 FC6A-D16R4CEE

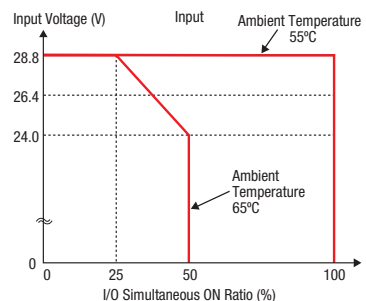

Output

FC6A-D16R1CEE
 FC6A-D16R4CEE

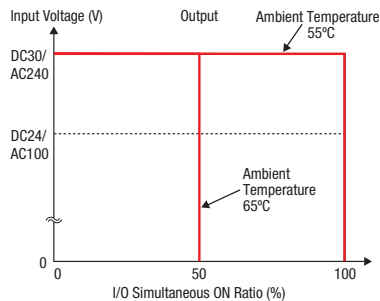

All-in-One / CAN J1939 All-in-One CPU Module (without cartridge)

Input

FC6A-C16R1AE
 FC6A-C16R1CE
 FC6A-C24R1AE
 FC6A-C24R1CE
 FC6A-C40R1AE
 FC6A-C40R1CE
 FC6A-C40R1AEJ
 FC6A-C40R1CEJ

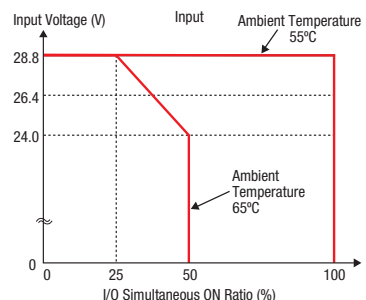

Output

FC6A-C16R1AE
 FC6A-C16R1CE
 FC6A-C24R1AE
 FC6A-C24R1CE
 FC6A-C40R1AE
 FC6A-C40R1CE
 FC6A-C40R1AEJ
 FC6A-C40R1CEJ

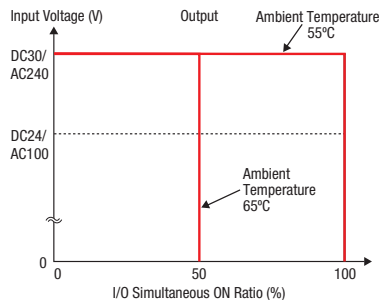

Input

FC6A-C16R1DE
 FC6A-C40R1DE
 FC6A-C40R1DEJ

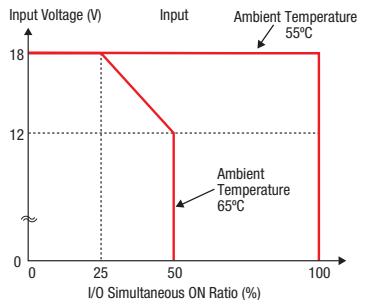

Output

FC6A-C16R1DE
 FC6A-C40R1DE
 FC6A-C40R1DEJ

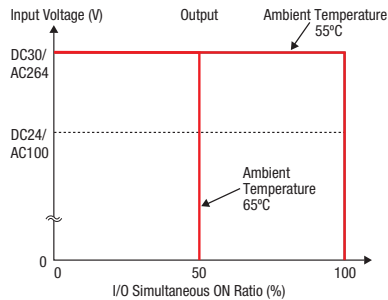

Input

FC6A-C16P1DE
 FC6A-C24P1CE
 FC6A-C40P1CE
 FC6A-C40P1DE
 FC6A-C40P1CEJ
 FC6A-C40P1DEJ

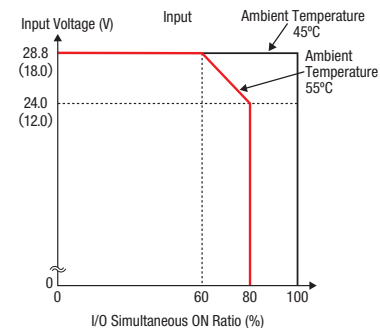

Output

FC6A-C16P1DE
 FC6A-C24P1CE
 FC6A-C40P1CE
 FC6A-C40P1DE
 FC6A-C40P1CEJ
 FC6A-C40P1DEJ

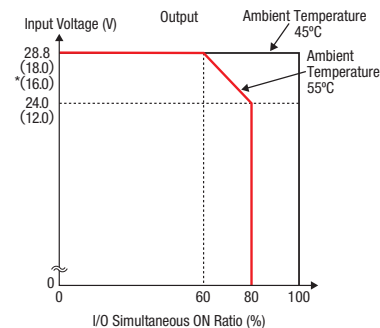

- Values in () are for 12V DC model.
- Values shown in * () are for CAN J1939 All-in-One CPU module.

All-in-One / CAN J1939 All-in-One CPU Module (with cartridge or when used under ambient temperature exceeding 55°C)

Input

FC6A-C16P1DE FC6A-C40P1CEJ
 FC6A-C24P1CE FC6A-C40P1DEJ
 FC6A-C40P1CE
 FC6A-C40P1DE

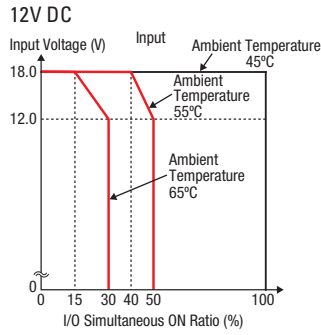
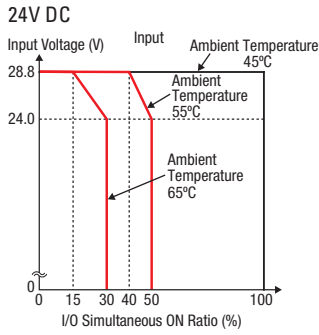

Output

FC6A-C16P1DE FC6A-C40P1CEJ
 FC6A-C24P1CE FC6A-C40P1DEJ
 FC6A-C40P1CE
 FC6A-C40P1DE

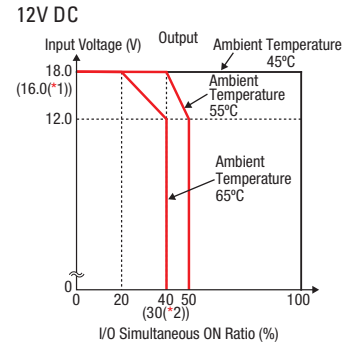
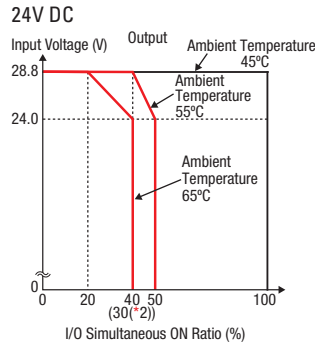

Input

FC6A-C16K1CE FC6A-C40K1DE
 FC6A-C16K1DE FC6A-C40K1CEJ
 FC6A-C24K1CE FC6A-C40K1DEJ
 FC6A-C40K1CE

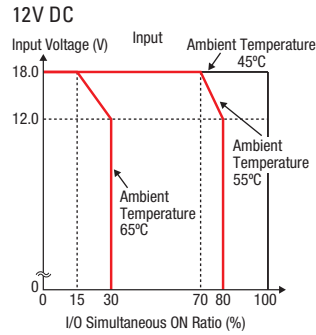
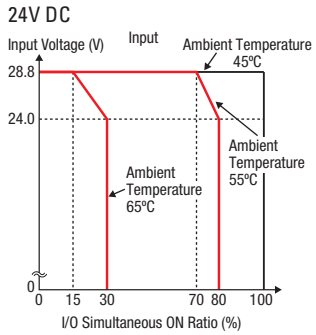

Output

FC6A-C16K1CE FC6A-C40K1DE
 FC6A-C16K1DE FC6A-C40K1CEJ
 FC6A-C24K1CE FC6A-C40K1DEJ
 FC6A-C40K1CE

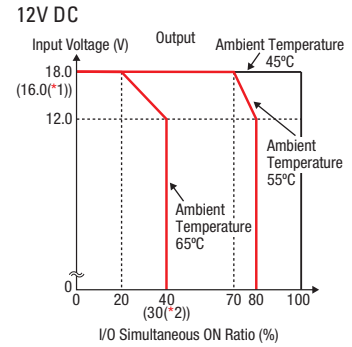
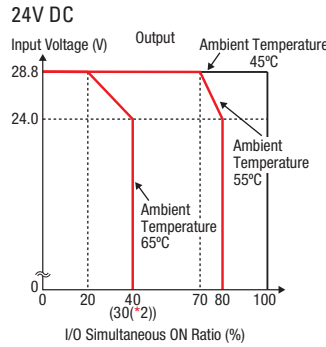

*1) Values shown in () are for CAN J1939 All-in-One CPU module.

*2) Values shown in () are for 16 I/O type All-in-One CPU module.

INPUT INTERNAL CIRCUIT

100V to 240V AC, 24V DC, 12V DC

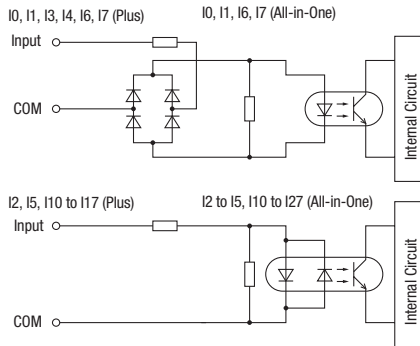

OUTPUT INTERNAL CIRCUIT

Transistor Sink Output

24V DC, 12V DC

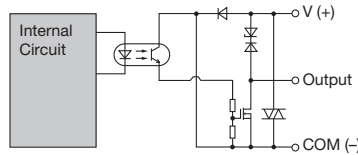

Transistor Source Output

24V DC, 12V DC

