

Easy Series PLC

High performance, compact, EtherCAT-enabled PLC



- Compact footprint
- A complete product range – from the simplest to the most complex motion control capable PLC
- PLCopen compliant axis control
- Simulation mode for offline debugging
- Real-time fieldbus



Easy series PLC: a comprehensive product range

Easy300



Ultra compact CPU
Easy301
RS232 + RS485

General CPU
Easy302
RS232 + RS485

CPU with Ethernet
Easy320
Dual Ethernet + RS485

Easy500

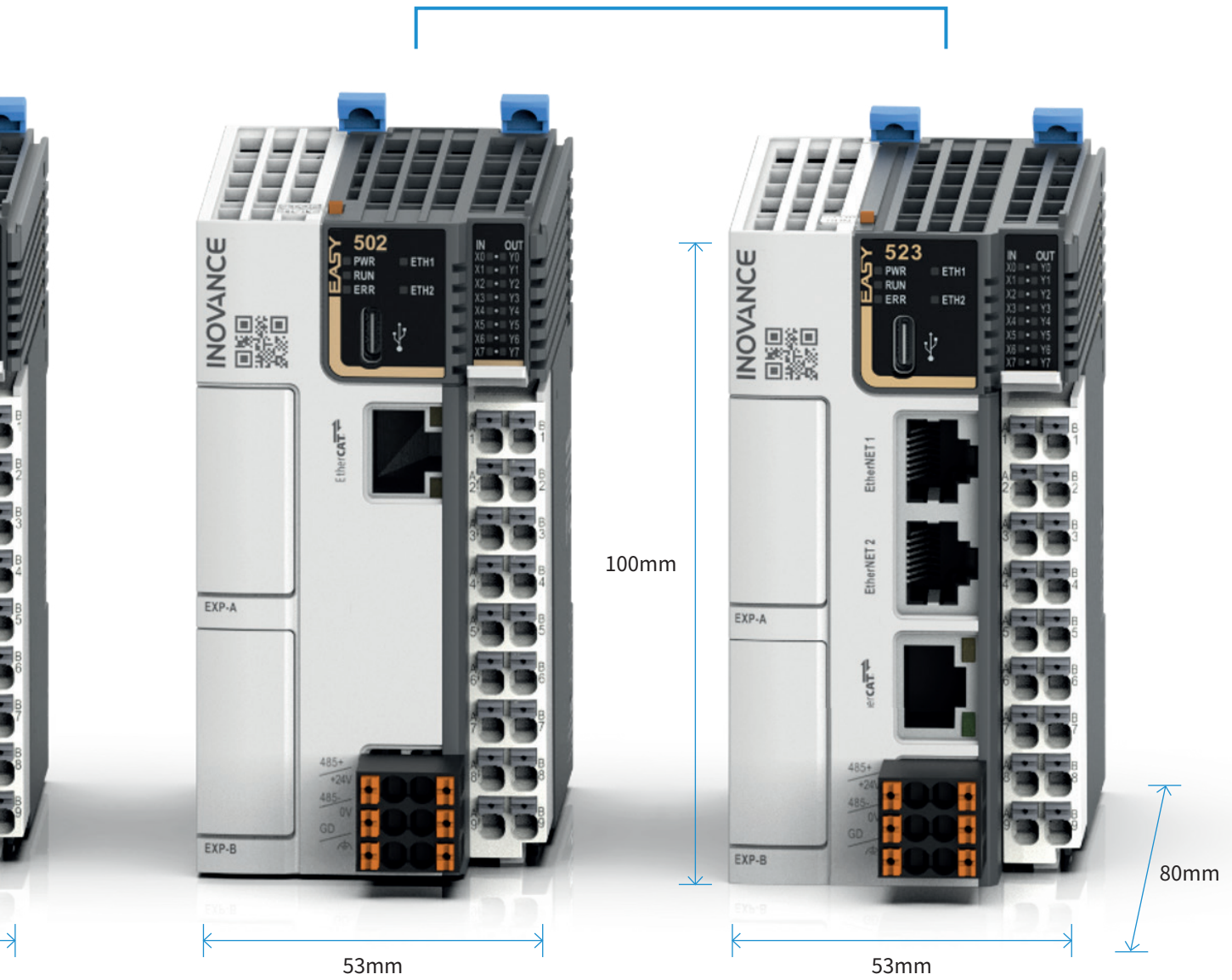

Motion control CPU
Easy502
EtherCAT + RS485

Motion control CPU with Ethernet
Easy523 Dual Ethernet
+ EtherCAT + RS485

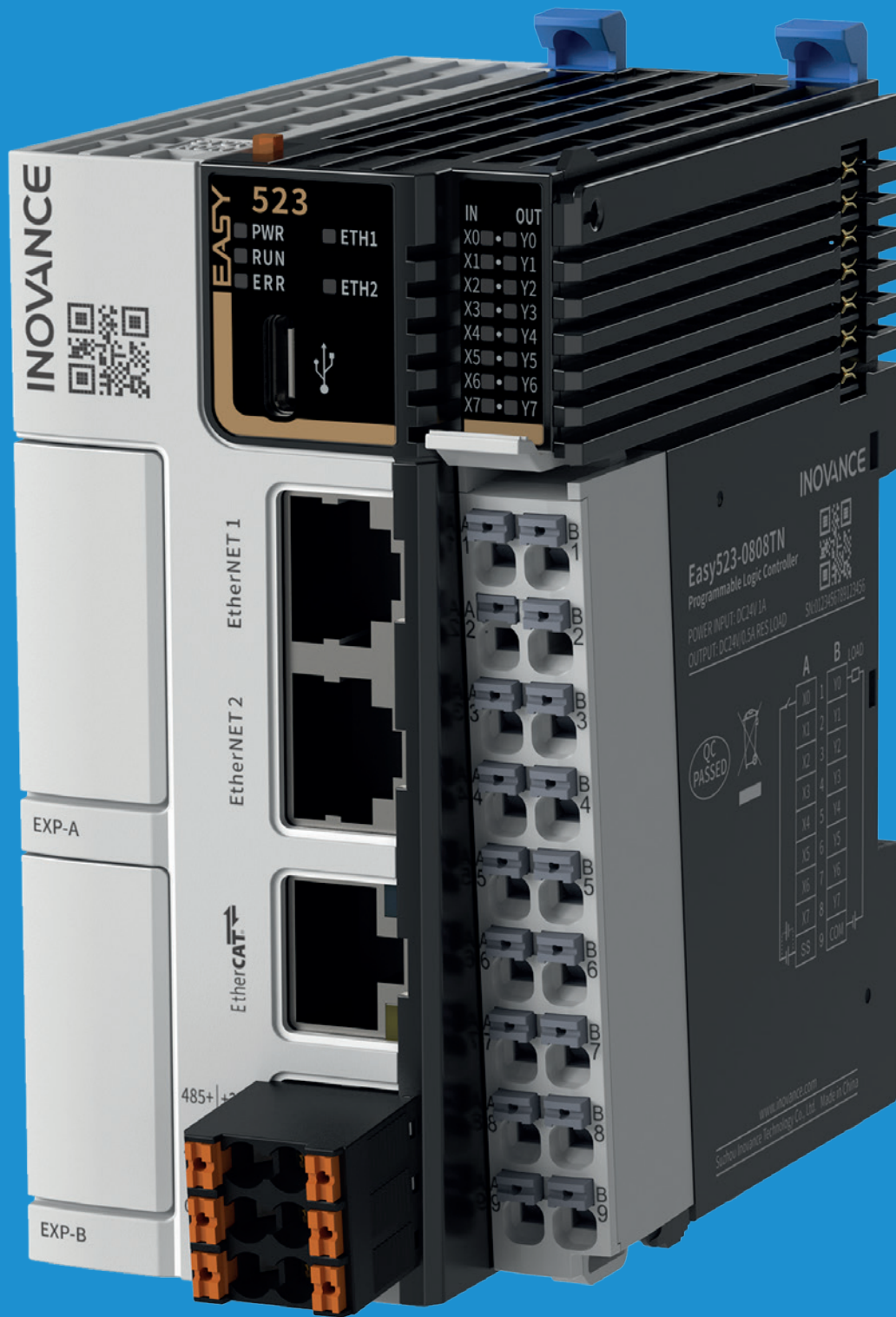

EASY programming

Customized FB/FC - self defined variable programming assistant



EASY assembly & wiring

Easy to add and/or replace modules. Plug in wires directly with spring clamp terminals

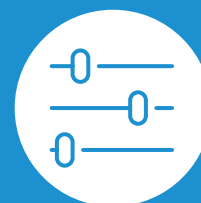

EASY commissioning

Auto device scanning, easy configuration, servo debug without programming, offline simulation



The type-C port works as a programming port allowing support programs, uploading/downloading and debugging.

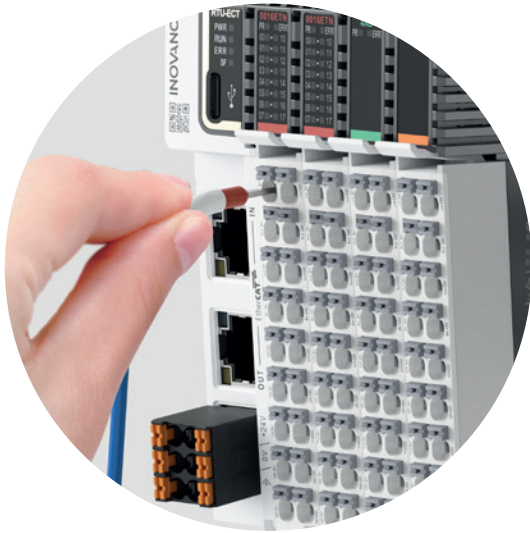

Easy wiring with spring clamp terminals.



'Slice type' compact I/O extension modules (GL20). Easy to plug in and remove for fast replacement.

Scalable system architecture

Multiple configurations

Easy301

Cost effective architecture using Modbus RTU communication and/or pulses to control the drives.

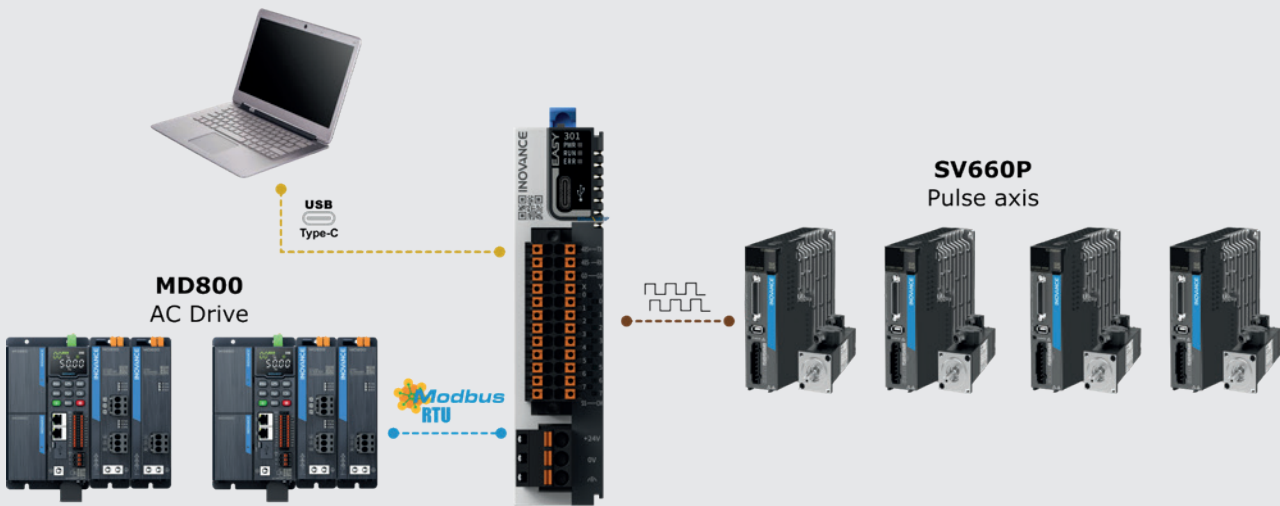

Easy302

Flexible architecture using CANopen communication and/or pulses to control the drives.

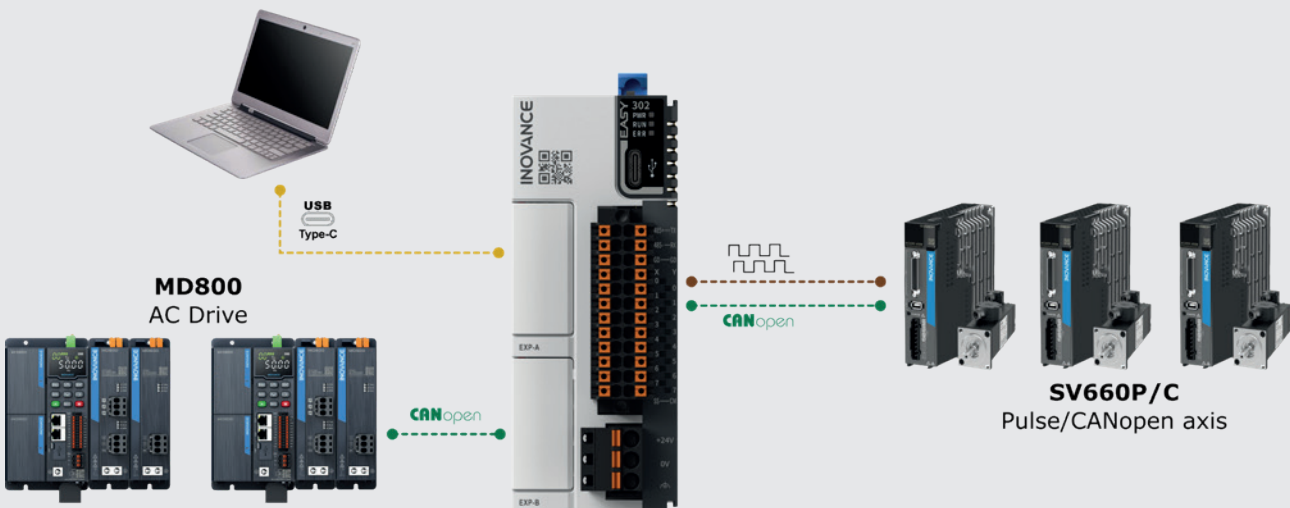

The Easy PLC series can cover anything from the simplest pulse control architecture to the most complex motion control applications using EtherCAT and Ethernet/IP

Easy320

Multiprotocol architecture using Ethernet/IP, CANopen communication and/or pulses to control the drives, and Modbus TCP with the HMI touchpanel

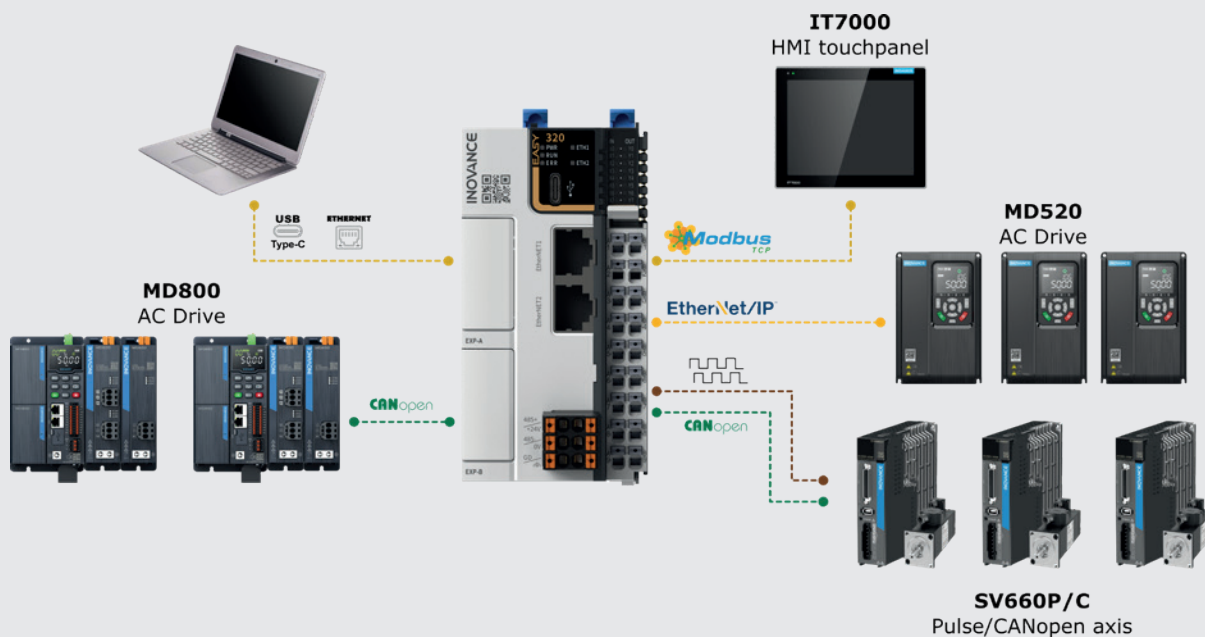

Easy523

Powerful motion control architecture using realtime EtherCAT communication and Ethernet/IP to control the drives, and Modbus TCP with the HMI touchpanel

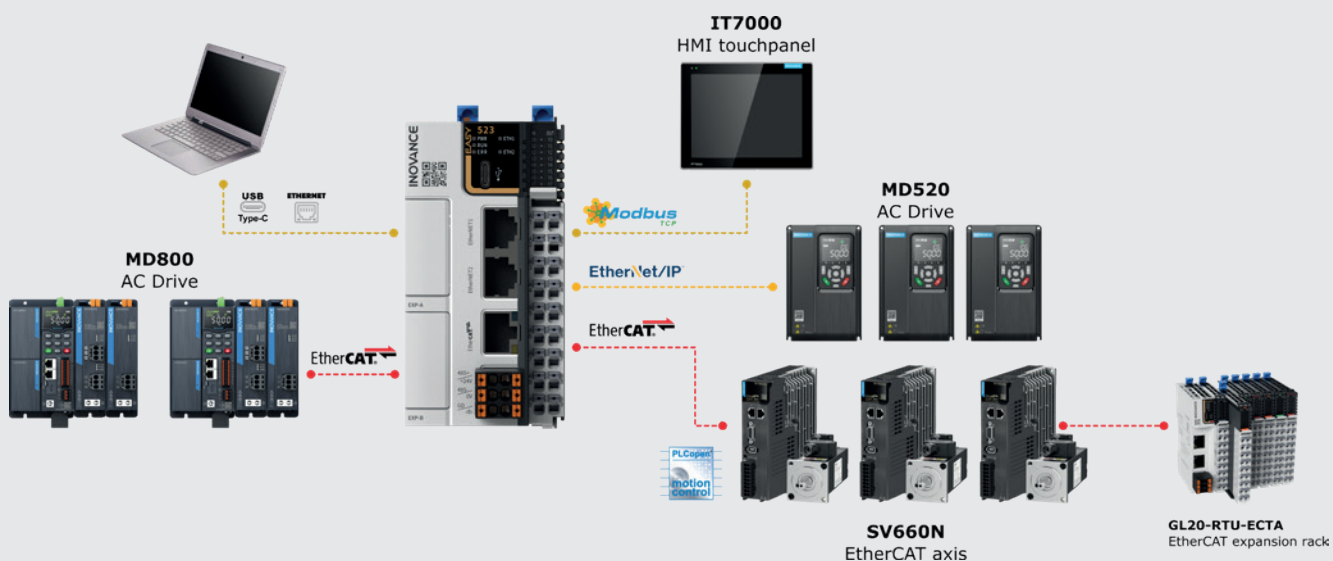

Specifications

Basic specifications of easy series controller

Item	Easy300		
	Easy301-0808TN	Easy302-0808TN	Easy320-0808TN
Motion axis	4 pulse control axes	5 pulse control axes	5 pulse control axes
Expansion modules (GL20)	8	16	
Extension slots (GE20)	–	2 (support communication/digital IO/analog IO/TF card/R)	
Ethernet	–	2 Modbus TCP up to 32 slaves EIP (under development)	
EtherCAT	–		
Serial communication	1 x RS232 1 x RS485 Support free protocol, Modbus RTU/ASC up to 16 slaves	1 x RS232, 1 x RS485 Support 1 x RS232/485 extension and 1 x CAN extension Support free protocol, Modbus RTU/ASC 16 slaves (recommended)	1 x RS485 Support 2 x RS232 /485 extension and 1 x CAN extension Support free protocol, Modbus RTU/ASC 16 slaves (recommended)
CAN communication	–	1 (require extension card), support CANlink/CANopen (up	
Program storage	128 K step		
Data storage	1 Mbyte (128 KB non-volatile) 150 KB soft element, non-volatile after No.1000		
Instruction execution time	20 K step / 2 ms		
Dimensions (WxHxD: mm)	24x100x83	40x100x83	53x100x80
Other interfaces	Type C	Type C, TF card (requires TF card extension module)	
CAM and interpolation	–	Supports CAM and interpolation motion	
Encoder axis	4 channel encoder axis (8 x high speed inputs, up to 200 KHz)		
Built in I/Os	8 inputs / 8 outputs		
Programming languages	LD, SFC, FB/FC (support encryption functionality), ST (under development)		
Power supply	DC24V		

¹Synchronised axes

²EtherCAT slaves include I/Os and synchronised and non-synchronised axes

Easy500	
Easy502-0808TN	Easy523-0808TN
A total of 16 synchronised axes are possible. This can be a max. of 16 EtherCAT axes ¹ , or a combination that includes a max. of five pulse control axes	A total of 32 synchronised axes are possible. This can be a max. of 32 EtherCAT axes ¹ , or a combination that includes a max. of five pulse control axes
TC)	
es	2
	Modbus TCP up to 32 slaves
	EIP (under development)
Support up to 72 EtherCAT slaves ² (including synchronised axes)	
1 x RS485 Support 2 x RS232/485 extension and 1 x CAN extension Support free protocol, Modbus RTU/ASC 16 slaves (recommended)	1 x RS485 Support 2 x RS232/485 extension Support free protocol, Modbus RTU/ASC 16 slaves (recommended)
to 62 slaves)	
200 k step	
2 Mbyte (128 KB non-volatile)	
20 K step / 1.6 ms	

Autoshop

A powerful PC tool is provided as standard

PLCopen FB

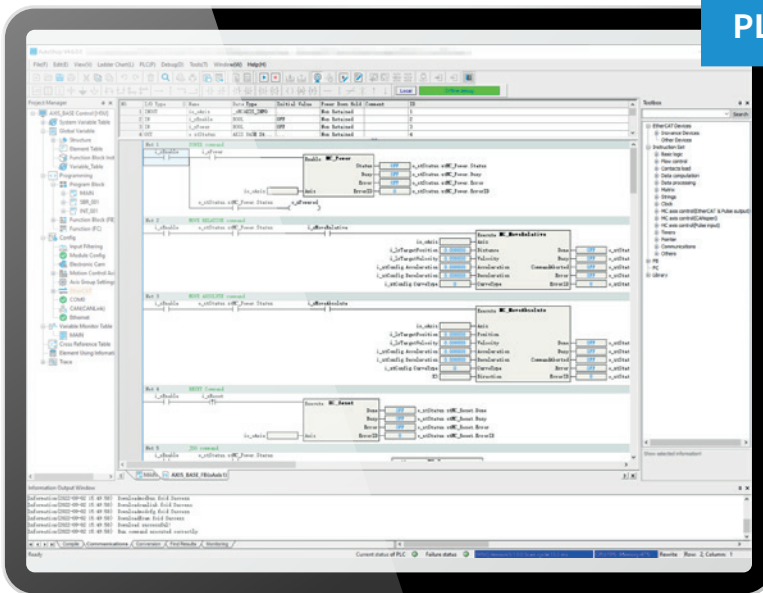

Hardware simulation

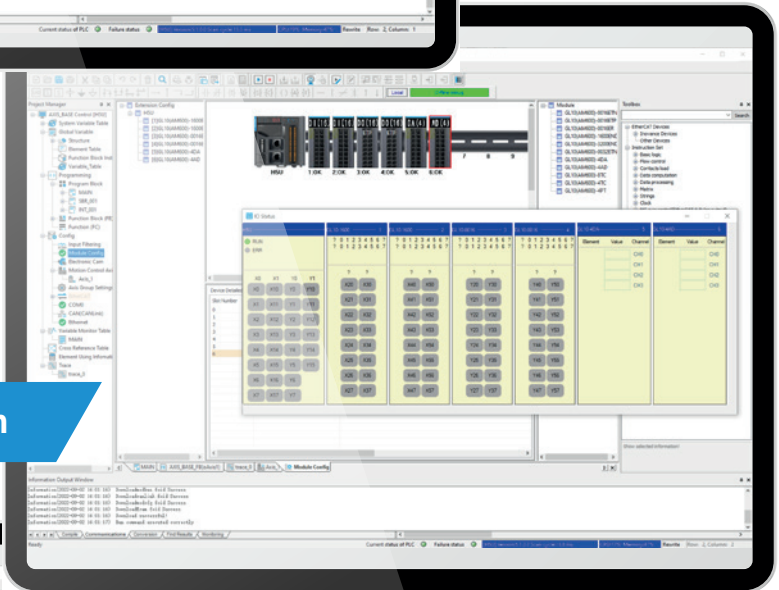

Easy hardware configuration

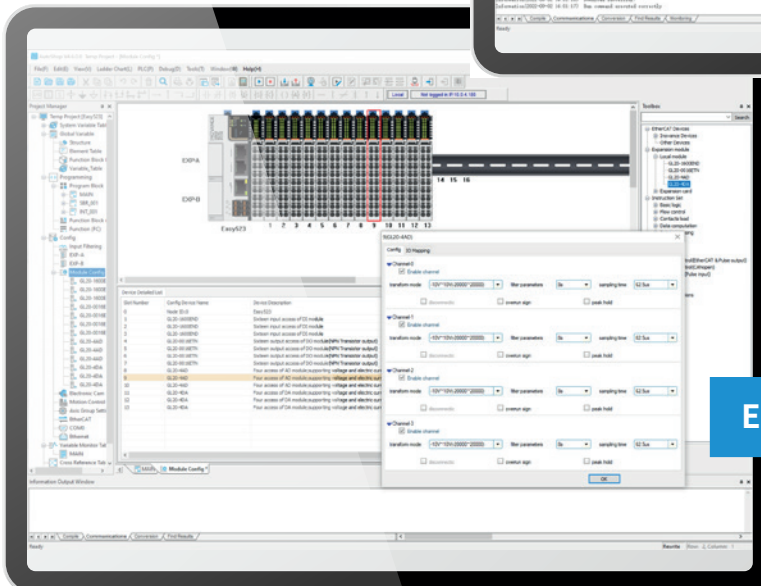

ST programming

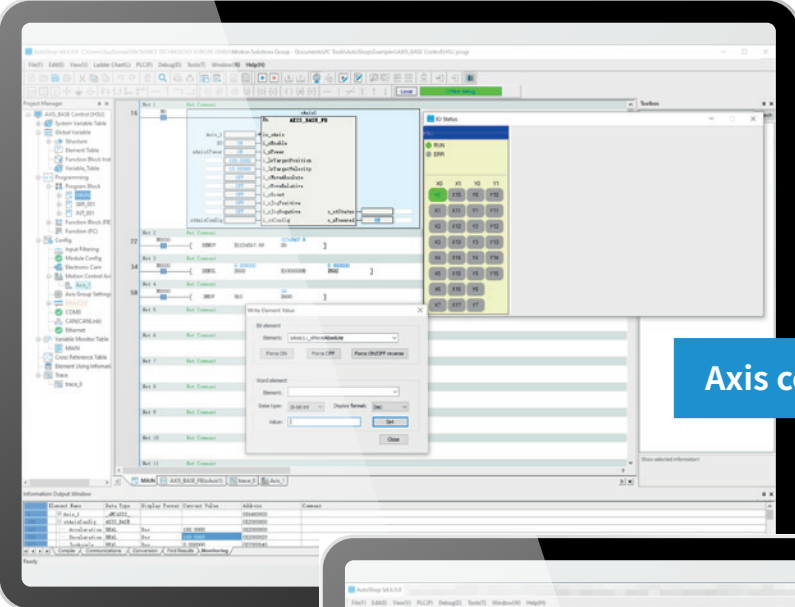
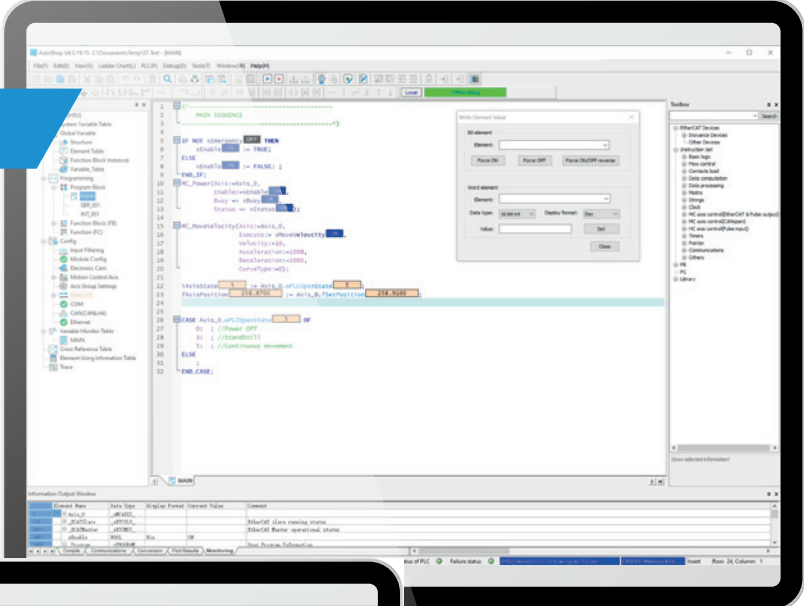

Axis commissioning tool

Trace

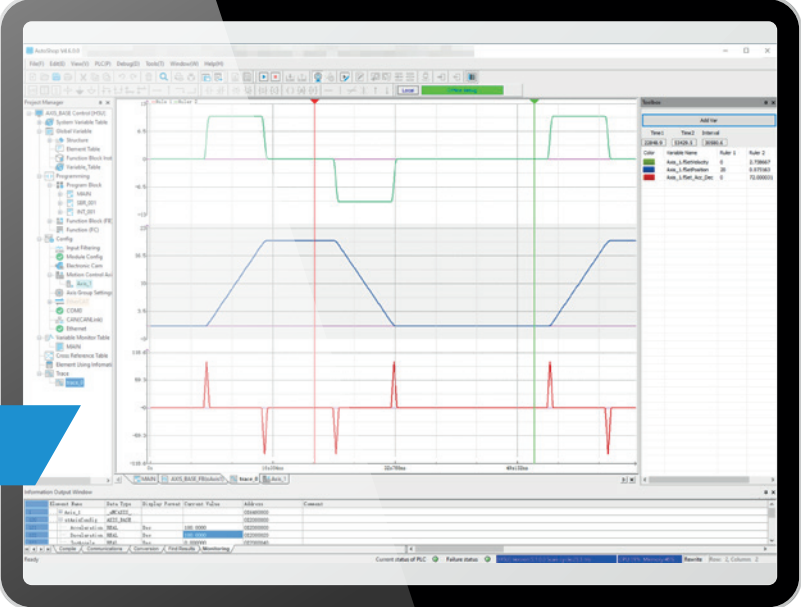

Extension capability

GE20 extension cards

Extension slot A

Extension slot B

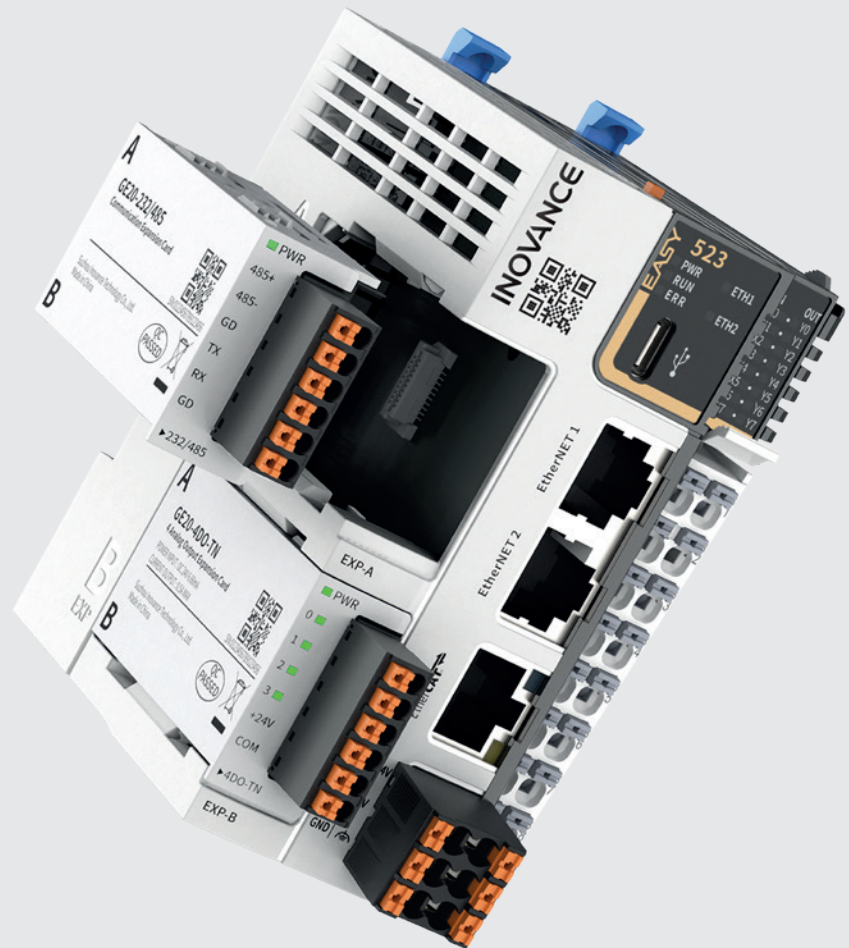

PLEASE NOTE

- RS485 connection - we recommend not more than 31 slaves
- CANopen supports up to 62 slaves
- CANlink supports up to 62 slaves
- Modbus TCP supports up to 32 slaves (working as client/master)
- Modbus TCP supports up to 16 masters (working as server/slave)
- Supports up to 3 serial ports (including extension card)
- Please note, extension cards are applicable to all CPU models except Easy301, and the CANopen card (GE20-CAN-485) cannot be used with the Easy523 CPU

	Extension card	Description	Slot A	Slot B
	GE20-4DO-TN	4 channel sink outputs	✓	✓
	GE20-4DI	4 channel source/sink inputs	✓	✓
	GE20-2AD1DA-I	2 analog inputs and 1 analog current output	✓	✓
	GE20-2AD1DA-V	2 analog inputs and 1 analog voltage output	✓	✓
	GE20-232/485-RTC	RS232/485 extension card with RTC		✓
	GE20-232/485	RS232/485 extension card	✓	✓
	GE20-CAN-485	CAN/RS485 extension card with RJ45 interface	✓	
	GE20-RTC	RTC extension card		✓
	GE20-TF	TF extension card		✓

Please note: extension card size: 54*30*1.2 (mm)

Expansion capability

GL20 modules – EtherCAT bus coupler



EtherCAT®

- ✓ Min. cycle time of 125 microseconds
- ✓ Allows EtherCAT alias configuration
- ✓ USB-C port for firmware upgrade

Specification	Description
Dimensions (WxHxD:mm)	24×100×83
Max. number of expansion modules	16
Protection	Over current/ reverse connection protection
Operating ambient temperature	-20~55°C
Operating ambient humidity	Less than 95% and no condensation
IP rating	IP20
Power supply	+24 VDC
Process data	Up to 1,024 input bytes and 1,024 output bytes
Mailbox size	Up to 256 input bytes and 256 output bytes
Alias	It admits the configuration of EtherCAT aliases through the master. Expansion modules connected behind ECT do not support alias access and configuration. Range: 1~65535
EtherCAT cycle	Min. cycle time of 125 microseconds
EtherCAT port	2 x RJ45
Communication rate	100 M, full duplex
Transmission distance	100 meters
Firmware update port	USB-C port for firmware upgrade

Expansion capability

GL20 expansion modules



Great performance with ultra fast response

Microsecond level response | Synchronous control



Compact size and wiring without tools

Compact size | Fast installation | Fast replacement



Stable and reliable design

Stable connection | Gold plating process | Safety and



Many variants to suit different systems

Multiple protocols | Many variants

Applicable to either bus coupler or CPU

se

NEW generation distributed I/O system

d reliability



GL20 slice type modules



Expansion capability

GL20 expansion modules



Compact Size

Saves 2/3 space during cabinet installation compared to our previous generation product – GL10

GL20 Series

Designed for compact cabinets

Thickness reduced to **12mm**

2/3 cabinet space saved

Space utilisation maximised

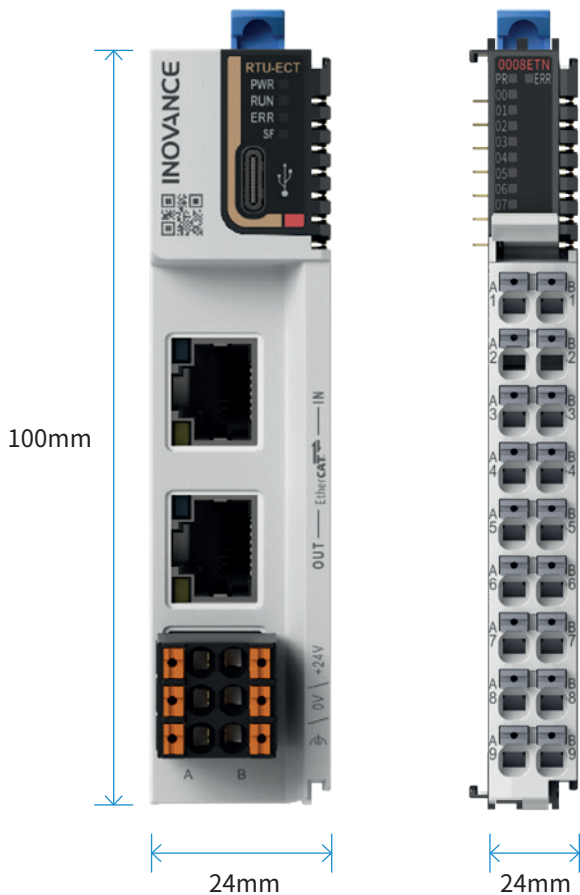
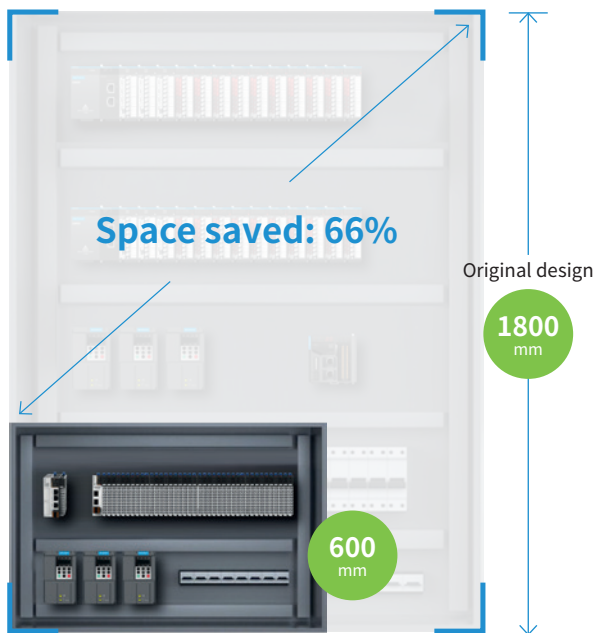

Compact design and tool-free wiring



Simple lever system allows easy removal of individual modules from the DIN rail



Easy wiring with 'plug and play' wiring terminals, with large 1.5mm² apertures



Supporting vertical plug-in/out

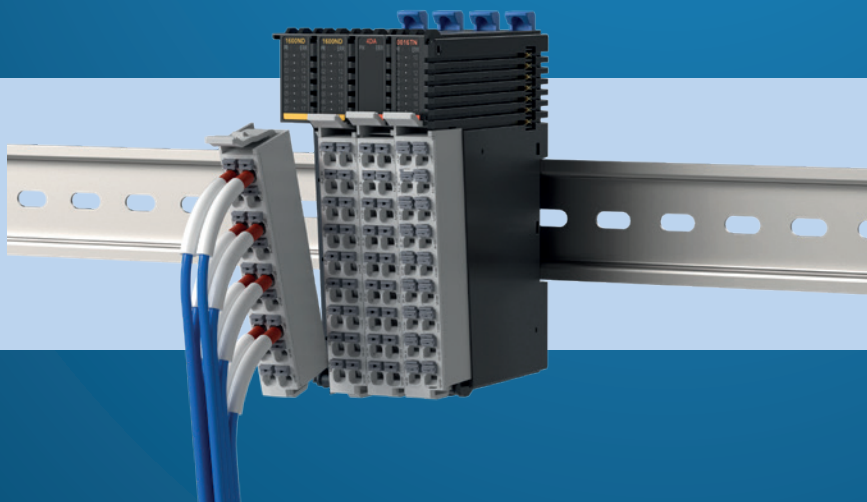

Removable terminals minimizes installation errors

Expansion capability

GL20 expansion modules

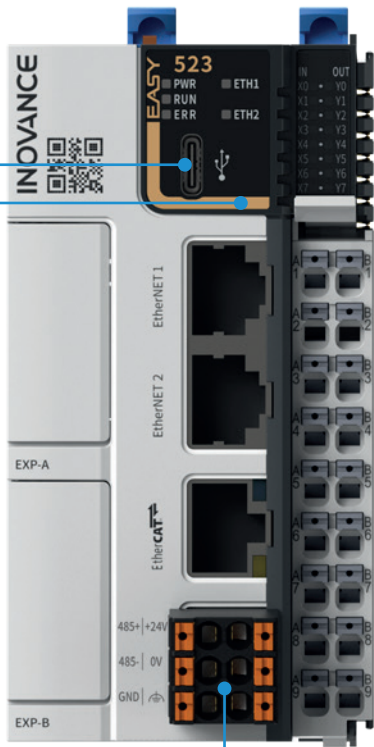

Main CPU

EtherCAT coupler

24VDC power supply
2 channels (A&B)

Wiring diagram

Type C port for firmware upgrade



I/O LED indicator

Label for each
connection
terminal

Digital outputs module

Analog outputs module

Digital inputs module

Analog inputs module

Communication module

Others



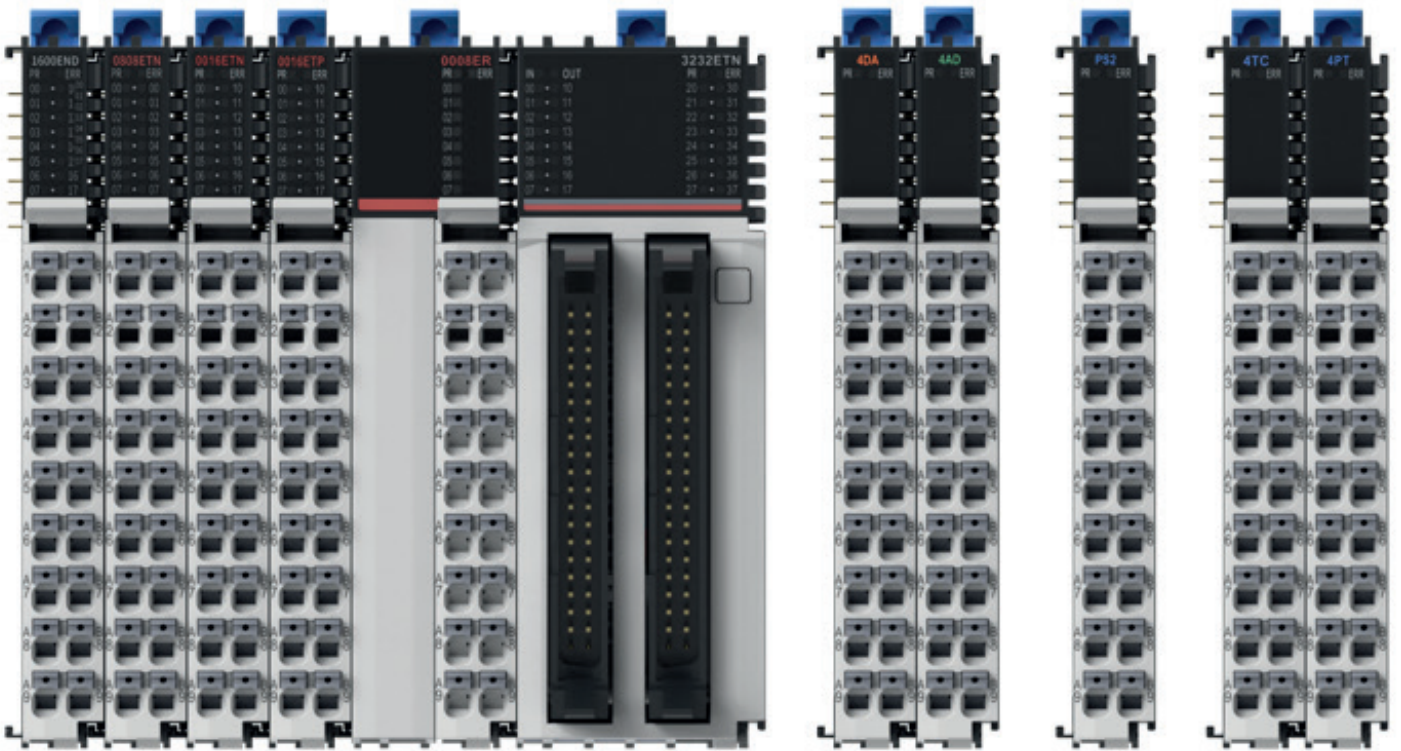

Type of Module	Model	Description
Bus coupler	GL20-RTU-ECT	EtherCAT slave bus coupler. Up to 16 expansion modules can be added
Digital input	GL20-1600END	16 x source (PNP)/sink (NPN) digital inputs module. Input filter from 0.25 ms to 32 ms
	GL20-0800END	8 x source (PNP)/sink (NPN) digital inputs module. Input filter from 0.25 ms to 32 ms
	GL20-3200END	32 x source (PNP)/sink (NPN) digital inputs module. Input filter from 0.25 ms to 32 ms
Digital output	GL20-0008ETP	8 x source (PNP) transistor outputs module. Response time 100 μ s
	GL20-0016ETP	16 x source (PNP) transistor outputs module. Response time 100 μ s
	GL20-0016ETN	16 x sink (NPN) transistor outputs module. Response time 100 μ s
Digital inputs/outputs	GL20-0808ETN	8 x source (PNP)/sink (NPN) digital inputs and 8 x sink (NPN) transistor outputs module
	GL20-3232ETN	32 x source (PNP)/sink (NPN) digital inputs and 32 x sink (NPN) transistor outputs module
Analog inputs/outputs	GL20-4AD	4 x analog inputs module (resolution 16 bits, sampling time 250 μ s)
	GL20-4DA	4 x analog outputs module (resolution 16 bits, sampling time 250 μ s)
Temperature detection	GL20-4PT	4 x channel thermal resistance inputs temperature detection module
	GL20-4TC	4 x channel thermocouple inputs temperature detection module

Dimensions

Easy301

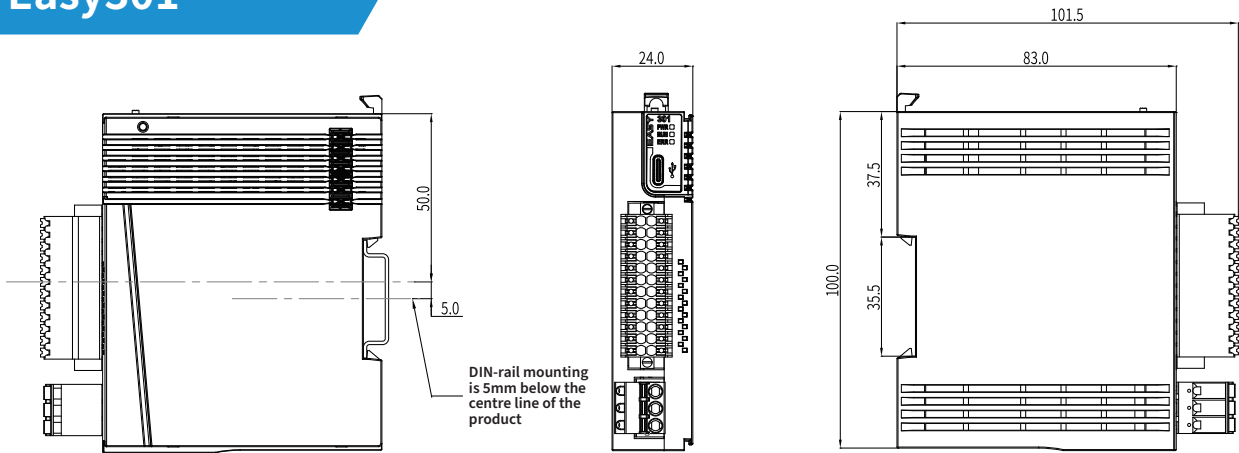

Easy302

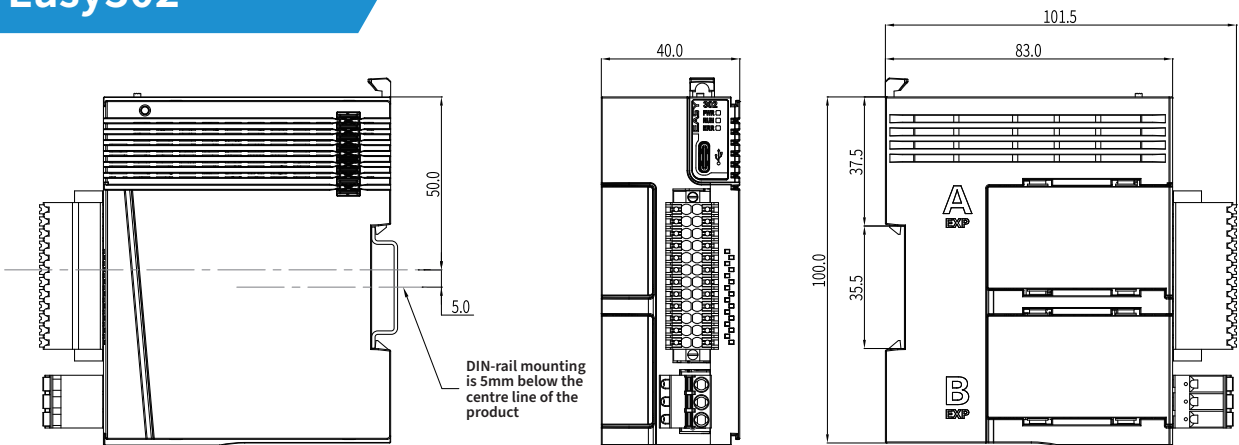

GL20-RTU-ECT

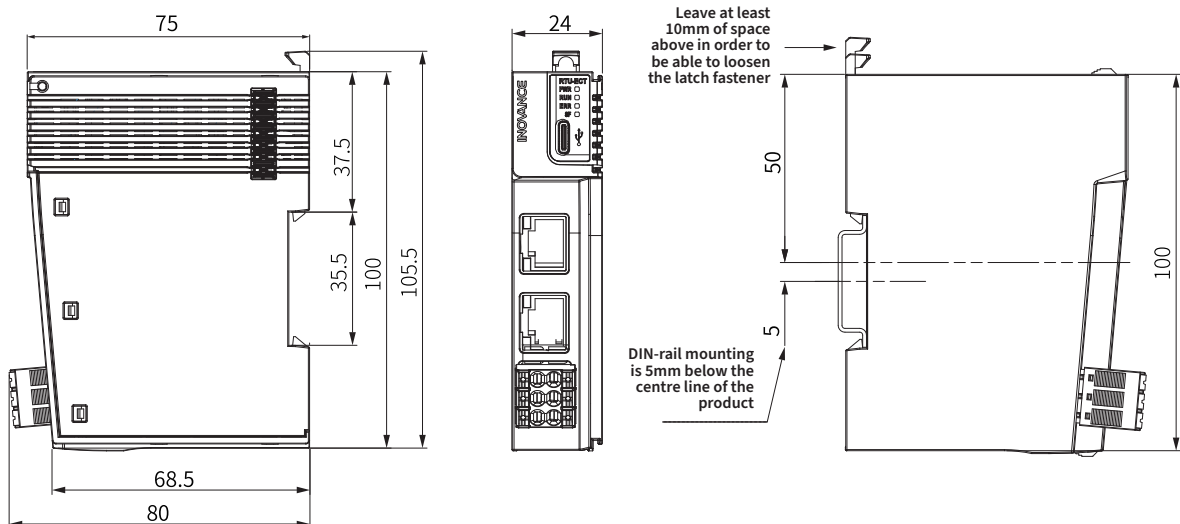

Easy320

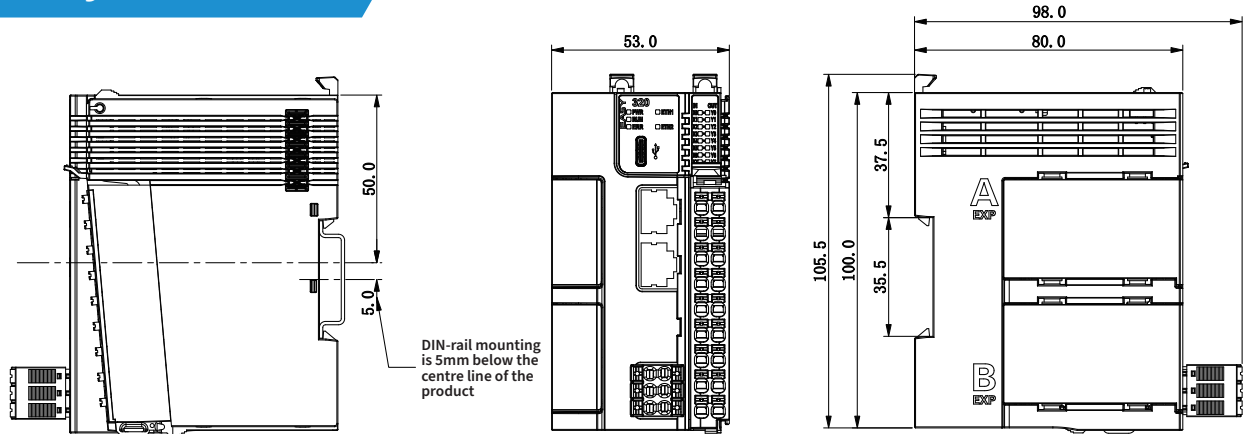

Easy502 & 523

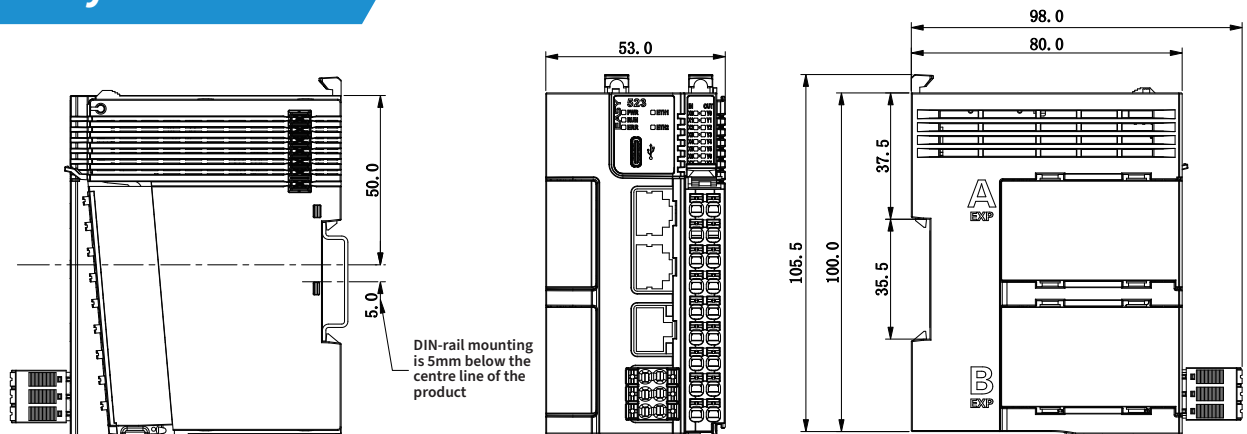

GL20-1600END, GL20-0800END, GL20-0008ETP, GL20-0016ETP, GL20-0016ETN, GL20-0808ETN, GL20-4AD, GL20-4DA

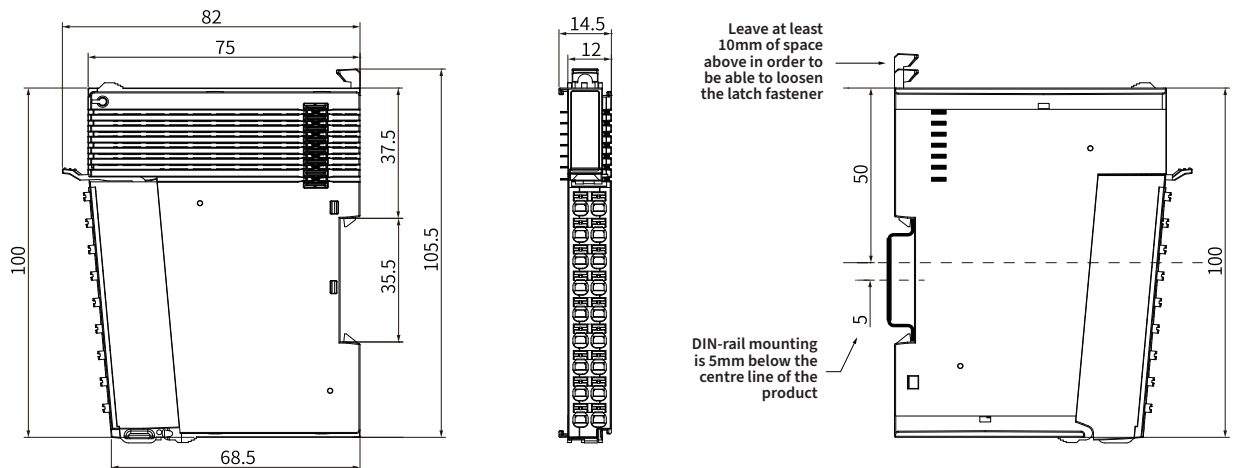

Driven by technology

AC drives



AC MultiDrives



MV drives



Single-Axis servos



Multi-Axis servos



Robotics & motion controllers



PLCs & HMIs



CNC machine tool solutions



Electric vehicle inverters

